



Caron Products & Services
OPERATIONS MANUAL



PRO2 FUME CABINET RANGE

MODELS: PR1004, PR1506, PR2008

Dear Valued Customer:

Thank you for purchasing CARON Products & Services equipment. We appreciate your business and look forward to being your preferred supplier of controlled environment equipment products in the future.

At CARON, we are committed to continuous quality improvement. Our goal is to supply our customers with highly reliable equipment at a fair price. In order to openly monitor our performance, we would appreciate your feedback on our products and services.

If you have questions, or any suggestions for improvement based on the installation or operation of the equipment you have purchased, please contact our service department at www.caronproducts.com or USA Tel 740-373-6809 – UK Tel +44-2392-266400.

Thanks again for your business!

REVISION LOG

Version	Date	Description
1	01/11/2022	Production Released
2	21/11/2022	UKCA Declaration of Conformity Updated
3	14/11/2023	Electrical Schematics Updated. Declaration of conformity updated.

Contents

REVISION LOG.....	3
EQUIPMENT LIMITED WARRANTY	6
EQUIPMENT INTERNATIONAL LIMITED WARRANTY	7
ABOUT THIS MANUAL	8
SAFETY INFORMATION.....	8
INTERNATIONAL SYMBOLS AND DEFINITIONS	9
1.0 INTRODUCTION	10
1.1 INTRODUCTION AND OPERATING PRINCIPLES	10
2.0 GENERAL CONSTRUCTION.....	11
2.1 MAIN FEATURES.....	11
3.0 INSTALLATION GUIDELINES.....	14
PART 1 - COMMISSIONING	15
4.0 COMISSIONING.....	16
4.1 COMMISSIONING GUIDELINES.....	16
4.2 FILTER INTEGRITY TEST	18
4.3 CONTAINMENT TEST.....	20
4.4 NEXTION TFT SYSTEM-OPERATOR CONTROLS	21
4.5 OPERATION, SEQUENCE	22
4.6 MAIN SCREEN.....	23
4.7 MENU SCREEN	27
4.8 SYSTEM CONFIGURATION SCREEN.....	28
4.9 AIRFLOW CALIBRATION SCREEN AND FUNCTIONS	30
4.10 NORMAL AIRFLOW CALIBRATION PROCEDURE	31
4.11 SETTING UP A 'NIGHTMODE' (STANDBY) AIRFLOW SETPOINT	32
4.12 FSA ALARMS.....	33
4.13 PASSWORDS.....	35
4.14 DATA ENTRY SCREEN	36
4.15 FAN ON-OFF	37
4.16 DATE AND TIME	38
4.17 UV.....	39
4.17.3 PROCEDURE FOR ACTIVATING THE UV CYCLE	40
PART 2 - OPERATING THE CHEMCAP PRO2 CABINET	42
5.0 OPERATING THE CHEMCAP PRO2 CABINET.....	43
5.1 To Operate the Cabinet:.....	43
5.2 Good Laboratory Practice	44
PART 3 - SERVICE MENUS	45
6.0 SERVICE MENUS (sub menu)	46
6.1 FILTER HOURS RUN SCREEN	47
6.2 UV HOURS SCREEN	48
6.3 ANNUAL SERVICE DATES.....	49
6.4 NETWORK SCREEN.....	51

6.5 Alpha Numeric Keyboard screen.....	52
6.6 DIAGNOSTIC SCREENS	53
6.7 USER PINS SCREEN.....	57
PART 4 -PREVENTIVE MAINTENANCE.....	58
7.0 EXAMINATION & TESTING	59
7.1 Statutory Examination, Testing and Preventative Maintenance-General	59
7.2 FACE VELOCITY.....	60
7.3 FILTER CONTAINMENT BREAKTHROUGH.....	61
7.4 CARBON FILTER CHANGE PERIOD-GUIDANCE	62
7.5 ELECTRICAL SAFETY	63
7.6 UV SAFETY	64
8.0 PREVENTATIVE MAINTENANCE.....	65
8.1 CLEANING AND CLEANLINESS STANDARD	66
8.2 CHANGING THE PRE-FILTERS	67
8.3 MAIN FILTER REMOVAL AND REPLACEMENT	68
8.4 RESETTING AIRFLOW VELOCITY.....	72
8.5 FILTER INTEGRITY TESTING	73
8.6 GUIDELINES TO SELECTING THE CORRECT FILTER TYPE-CHANGE OF USE	74
8.7 TROUBLESHOOTING	75
8.8 SPARE PARTS LIST	76
PRODUCT SPECIFICATIONS	77
PRODUCT SPECIFICATIONS – POWER AND WEIGHT	78
FILTER SELECTION.....	79
DIMENSIONAL REFERENCES-PRO2 MODELS.....	80
EU DECLARATION OF CONFORMITY	81
UKCA DECLARATION OF CONFORMITY.....	84
APPENDIX 1	87
APPENDIX 2 – ELECTRICAL SCHEMATIC.....	88

EQUIPMENT LIMITED WARRANTY

Please review this section before requesting warranty service. At CARON, one of our primary goals is to provide customers with high levels of personal service and top quality products, delivered on time, backed by technical service and supported for the life of the product.

Before contacting us for warranty service, please be aware that there are repairs that are not covered under warranty.

WARRANTY DEFINED

Caron Products & Services, Inc. (herein after CARON) hereby warrants that equipment manufactured by CARON is free from defects in materials and workmanship when the equipment is used under normal operating conditions in accordance with the instructions provided by CARON.

COVERED:

- Parts and labor for a period of two (2) years from date of shipment.
- Any part found defective will be either repaired or replaced at CARON's discretion, free of charge, by CARON in Marietta, OH. Parts that are replaced will become the property of CARON.
- If CARON factory service personnel determine that the customer's unit requires further service CARON may, at its sole discretion, provide a service technician to correct the problem, or require the return of the equipment to the factory or authorized service depot.
- CARON will have the right to inspect the equipment and determine the repairs or replacement parts necessary. The customer will be notified, within a reasonable time after inspection, of any costs incurred that are not covered by this warranty prior to initiation of any such repairs.

NOT COVERED:

- Calibration of control parameters.
- Improper installation; including electrical service, gas and water supply tubing, gas supplies, room ventilation, unit leveling, facility structural inadequacies or ambient conditions that are out of specification.
- Cost of express shipment of equipment or parts.
- Any customer modifications of this equipment, or any repairs undertaken without the prior written consent of CARON, will render this limited warranty void.
- CARON is not responsible for consequential, incidental or special damages; whether shipping damage or damages that may occur during transfer to the customer's point of use. When the equipment is signed for at the customer's site, ownership is transferred to the customer. Any damage claims against the shipping company become the responsibility of the customer.
- Repairs necessary because of the equipment being used under other than normal operating conditions or for other than its intended use.
- Repair due to the customer's failure to follow normal maintenance instructions.
- Parts considered consumable; including: light bulbs, filters, gases, etc.
- Damage from use of improper water quality.
- Damage from chemicals or cleaning agents detrimental to equipment materials.
- Force Majeure or Acts of God.

This writing is a final and complete integration of the agreement between CARON and the customer. CARON makes no other warranties, express or implied, of merchantability, fitness for a particular purpose or otherwise, with respect to the goods sold under this agreement. This warranty cannot be altered unless CARON agrees to an alteration in writing and expressly stated herein shall be recognized to vary or modify this contract.

Ohio Law governs this warranty.

EQUIPMENT INTERNATIONAL LIMITED WARRANTY

Please review this section before requesting warranty service. At CARON, one of our primary goals is to provide customers with high levels of personal service and top quality products, delivered on time, backed by technical service and supported for the life of the product.

Before contacting your distributor for warranty service, please be aware that there are repairs that are not covered under warranty.

WARRANTY DEFINED

Caron Products & Services, Inc. (herein after CARON) hereby warrants that equipment manufactured by CARON is free from defects in materials and workmanship when the equipment is used under normal operating conditions in accordance with the instructions provided by CARON.

COVERED:

- Parts for a period of two (2) years from date of shipment.
- Any part found defective will be either repaired or replaced at CARON's or their authorized representative's discretion. Parts that are replaced will become the property of CARON.
- If CARON or their authorized representatives determine that the customer's unit requires further service, CARON or the representative may, at its sole discretion, provide a service technician to correct the problem, or require the return of the equipment to the an authorized service depot.
- CARON or their authorized representative will have the right to inspect the equipment and determine the repairs or replacement parts necessary. The customer will be notified, within a reasonable time after inspection, of any costs incurred that are not covered by this warranty prior to initiation of any such repairs.

NOT COVERED:

- Calibration of control parameters.
- Improper installation; including electrical service, gas and water supply tubing, gas supplies, room ventilation, unit leveling, facility structural inadequacies or ambient conditions that are out of specification.
- Cost of express shipment of equipment or parts.
- Any customer modifications of this equipment, or any repairs undertaken without the prior written consent of CARON, will render this limited warranty void.
- CARON and their representative are not responsible for consequential, incidental or special damages; whether shipping damage or damages that may occur during transfer to the customer's point of use. When the equipment is signed for at the customer's site, ownership is transferred to the customer. Any damage claims against the shipping company become the responsibility of the customer.
- Repairs necessary because of the equipment being used under other than normal operating conditions or for other than its intended use.
- Repair due to the customer's failure to follow normal maintenance instructions.
- Parts considered consumable; including: light bulbs, filters, gases, etc.
- Damage from use of improper water quality.
- Damage from chemicals or cleaning agents detrimental to equipment materials.
- Force Majeure or Acts of God.

This writing is a final and complete integration of the agreement between CARON and the customer. CARON makes no other warranties, express or implied, of merchantability, fitness for a particular purpose or otherwise, with respect to the goods sold under this agreement. This warranty cannot be altered unless CARON agrees to an alteration in writing and expressly stated herein shall be recognized to vary or modify this contract.

Ohio Law governs this warranty.

Caron Products & Services, Inc.
 PO Box 715 · Marietta, OH 45750
 740-373-6809

ABOUT THIS MANUAL

This User Manual is intended to provide guidance for the **Installation, Commissioning, Operation and Servicing** of the PRO2 Fume cabinet range.

This manual's descriptions do not describe the functionality or processing of the final system into which this product may be incorporated. Reference should be made to other applicable documentation.



SAFETY INFORMATION

HAZARDS

During servicing and maintenance, this equipment can potentially cause danger through exposure to used (contaminated) filters, the employment of high voltages¹ and high-speed rotating fans where access panels are opened.

Failure to observe the recommendations in this manual will constitute a SAFETY OR ELECTRICAL SHOCK HAZARD

INSTALLATION, COMMISSIONING, OPERATION AND SERVICING

The equipment must be operated and serviced as recommended in this manual, otherwise the electrical protection and/or the airflow integrity of the cabinet could be compromised. Any such installation or use may affect the terms and conditions of any guarantees and warranties.

PRODUCT GUARANTEE

Caron guarantees that this product is free from defects in materials and workmanship when shipped from the factory and will replace or repair the unit if it proves defective in normal use or during service for a period of 12 months from delivery and commissioning. This guarantee is invalidated if the unit is used incorrectly, poorly serviced, misused or accidentally damaged.

ENVIRONMENT

- This product is intended for indoor use;
- It is not designed or certified for use in a potentially explosive environment as defined in ATEX Directive 94/9/EC.
- Temperature range: 15°C to 32°C
- Humidity: Max RH 80% for temperatures up to 31°C.
- Mains supply voltage fluctuations up to ± 10% of nominal voltage 240V
- Mains supply voltage: 110V to 120V AC
- Containment & Operator Protection

Safe, acceptable levels of hazardous substances containment, for operator protection can only be assured whilst the cabinet is fully operating, developing correct airflow face velocity under normal conditions. In the event of a power failure, all substances under process should be removed from the enclosure (to a separate safe environment), or separately sealed whilst within the enclosure, with all doors remaining closed.

FIRE OR EXPLOSION RISK

There are no direct sources of ignition within the working zone of the cabinet and no intrinsic risk of fire or explosion during normal use. The acrylic enclosure may only provide initial containment should a fire occur, caused by flammable materials and an ignition source introduced during a process by the end-user. Adequate risk assessment must be applied to determine the potential hazards posed by all processes to be undertaken.

¹ Defined in LV Directive 2006/95/EC as voltages of 50VAC-1000VAC, 75VDC-1500

INTERNATIONAL SYMBOLS AND DEFINITIONS

The equipment is fitted with identification and ISO/ANSI safety hazard warning labels shown below, which uniquely identifies the product, validation and safety information. These labels must not be removed or defaced, as evidence of compliance to Quality Assurance Tests, and CE Mark may be lost.



Warning of hazardous area



Warning of dangerous electric voltage



UV-C Radiation from The Biocidal Lamp is Harmful to Both Eyes and Skin



Earth (ground) protective conductor



Tested For
Electrical Safety

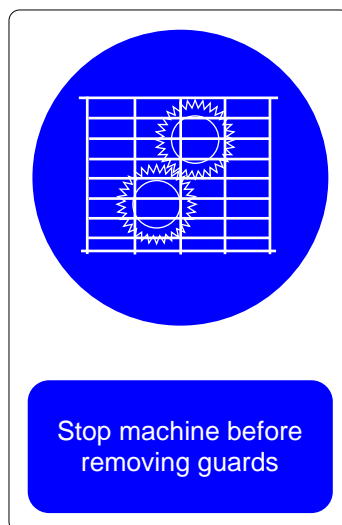

Warning Label Fan
Label Guard

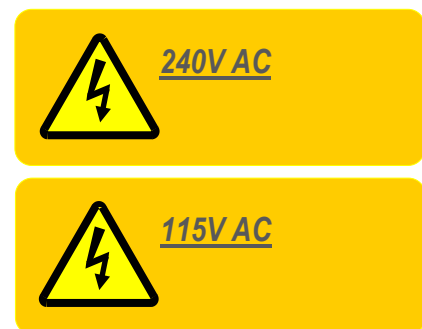

Warning Label
Operating Voltage

WARNINGS



The use of the WEEE Symbol indicates that this product cannot be treated as household waste at end-of-life.

By ensuring that this product is disposed of correctly, you will help protect the environment.

For more detailed information about the recycling of this product, please contact your supplier,

Restriction of the use of certain Hazardous Substances (RoHS) 2011/65/EU as amended

1.0 INTRODUCTION

This Manual is applicable to the following products:

CHEMCAP PRO2™ MODELS: PR1004, PR1506, PR2008

1.1 INTRODUCTION AND OPERATING PRINCIPLES

Caron's Chemcap PRO2™ Ductless Fume Cabinet employ advanced airflow and containment protection from very toxic fumes, vapours and particulates in order to meet current COSHH 2002 regulations. Incorporating both main and back-up carbon filters coupled with HEPA filtration, they provide outstanding retention and capture capabilities.

Designed as bench mounted equipment, they are built, tested and approved to exacting compliance standards, for the safe handling and containment of a variety of substances, including solvents, acids and particles with excellent all round visibility, accessibility, and high level operator protection with minimum maintenance.

When used as part of comprehensive laboratory procedures, and following the recommendations in this manual, your Chemcap Pro2™ cabinet will provide optimum protection handling toxic substances, together with extended filter life.

During normal operation, room/laboratory air enters the 'trapezium' style aperture at the front of the enclosure under the influence of the negative pressure side of the high-performance centrifugal fan mounted in the Fan/Filter housing. This creates the required negative pressure environment within the acrylic enclosure.

Filtration of the laboratory make up air is achieved first by pre-filtering, followed by filtration by the Enviro™ Carbon filters and HEPA filter, exhausting under positive pressure as fully filtered clean air. This volume air exchange is repeated continuously and in the process will enhance the quality of the room/laboratory air making it a safer, more pleasant place to work.

The airflow developed by the fan is preset to provide a capture velocity of >0.5 m/sec, and provides the essential barrier between airborne vapours or aerosols occurring within the enclosure and continuous safety of the operator, giving the highest level of containment possible for a ductless filtration fume cabinet.

The incorporation of a back-up carbon filter removes the risk of the lower (main) carbon filter reaching its saturation point after extended use and allowing potential breakthrough of hazardous substances to occur.

Airflow calibration, low airflow alarm, service and filter saturation indicators are provided by the integrated 'Nextion TFT' airflow and alarm control system.

2.0 GENERAL CONSTRUCTION

In this section the general components of the unit are given with a detailed explanation for the key components of a unit.

2.1 MAIN FEATURES

The cabinet is constructed as a frameless enclosure using optically clear 'safe-edged', fire-retardant and chemical resistant acrylic, providing a range of sizes and configurations (see Dimensional References). Mounted on top of the acrylic enclosure is the fully welded hinged steel housing, incorporating fan, control panel and Nextion TFT screen airflow and alarm control panel, IEC power inlet socket. Immediately below this is a removable steel grille, which houses the pre-filter element.

To gain access to the integral lighting and sampling port of the chamber, the front fascia panel hinges open in an upward direction.

To gain full access to the filtration system the hinged upper-section of the fan housing must be lifted further in order to manoeuvre the installed chemical and particulate filters for removal and replacement. Jacking screws are incorporated to assist in the safe opening and securing of the fan housing when lifted for access.

2.1.1 ACCESS DOORS

Bi folding hinged doors; manufactured from the same 8mm fire-retardant, acrylic panels are located at the front face of the enclosure and can be fully opened to provide complete access to the interior.

The hinged door assembly is secured by tool-operated securing catches fitted both sides.

A 'trapezium style' access aperture(s) is incorporated within the lower door panel for operator access during normal operation.

2.1.2 PRE-FILTER FUNCTION

A single, pre-filter provides 'first-stage' particle filtration, which improves overall efficiency and extends the life of the main filter. The pre-filter can be removed under negative pressure without having to open the fan/filter housing above and therefore provides a safe-change method during servicing.

2.1.3 4-STAGE MAIN FILTRATION

incorporate a 4-stage filtration system as standard, comprising pre-filter, two high-performance 'Enviro™' (activated carbon) filters and a HEPA particulate filter. An alloy sampling chamber frame with sampling port connection is fitted between the two Enviro filters and allows owners to carry out regular sampling of the inter-filter gases.

Optional, specific chemical capture Enviro™ filter types can be fitted together with ULPA filter combinations. (Pro1506 and Pro2008 incorporate 2 sets of filters side by side).

Figure 1
FILTRATION SYSTEM

The 4-stage filtration process

Function

Description

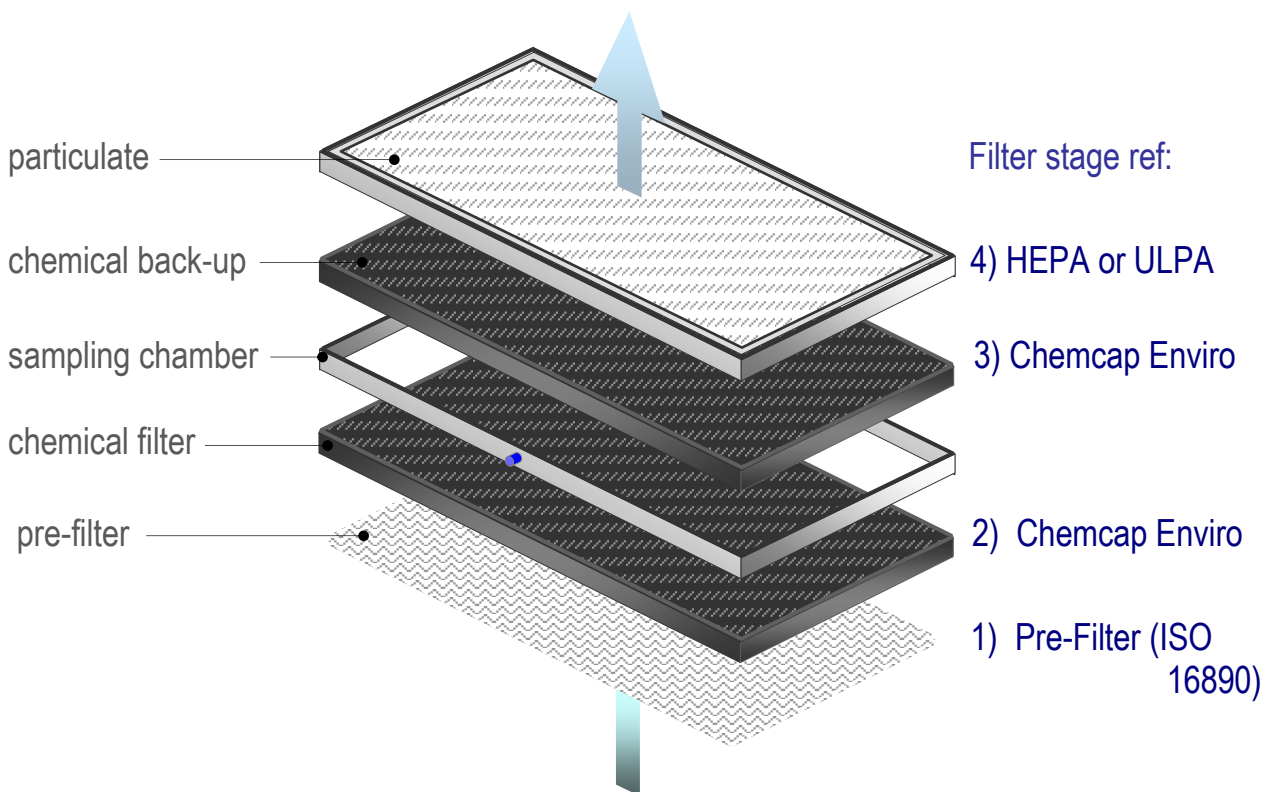

2.1.4 FAN(S)

A dynamically balanced, thermally protected, centrifugal fan is assembled within the plenum assembly of the Fan/Filter housing.

The fan produces negative pressure airflow at the intake aperture and maintains the required velocity throughout the enclosure. (Pro1506 and Pro2008 models incorporate 2 fans).

2.1.5 INTERNAL TRAY

A full-width removable polyvinyl chloride base tray is incorporated at the base of the cabinet to accommodate spills during processes.

2.1.6 INTERNAL LIGHTING

An LED lamp is installed beneath the front panel of the fan/filter housing. It is external to the enclosure interior and does not affect the airflow pattern or containment integrity of the cabinet.

3.0 INSTALLATION GUIDELINES

Follow the below guidelines to ensure safe use and unpacking along with optimum operation of the unit.

3.0.1 UNPACKING

Where supplied 'flat-packed' the cabinet will require re-assembling on site by trained installation personnel. All component parts must be carefully unpacked, and the protective film should remain on the acrylic panels intact until the cabinet is fully assembled and ready for commissioning.

3.0.2 SITE SELECTION

For operator safety and reliable function, the cabinet should be placed on a firm and level bench/work surface, or on top of the (optional) custom trolley frame.

3.0.3 AIRFLOWS AND PRESSURE REGIMES

To avoid air currents and pressure fluctuations in the room affecting the overall performance of the safety cabinet, it should be positioned well away from direct sources of disruptive air changes such as open windows, doors etc. Room air velocity should not exceed 0.25m/s.

3.0.4 GENERAL INSTALLATION RECOMMENDATIONS

The following environment requirements should be considered during installation:

- Ambient temperature: from 15°C to 32°C
- Relative humidity: RH < 80% at 30°C
- Recommendations as detailed in BS 14175:4 2003.
- Refer to HSG 258 guide to local exhaust ventilation for your requirements

3.0.5 NOISE LEVELS

The noise generated by the fan and resulting air movement will not rise above measured limits during normal operation, with the bi-folding access door closed and secured.

3.0.6 CLEANLINESS STANDARD

The site should be maintained as clean and dust free as possible, since the cleaner the environment the more efficient the filtration will be and also help to reduce pre-filter maintenance costs. Use a damp cloth, to clean the exterior surfaces of the cabinet, regularly, particularly the front and side surfaces, to remove accumulated dust.

NOTE:

Do not use solvent-based chemicals to clean the acrylic panels, particularly on a regular basis as this may promote stress cracking of the acrylic material.

3.0.7 ELECTRICAL CONNECTION

The Cabinet must be earthed

Connect the cabinet to an adjacent, earthed and switched supply of 115 Volts, single phase, ~ 60Hz outlet or 230 Volts, single phase, 50/60Hz outlet using the IEC mains lead supplied

PART 1 - COMMISSIONING

4.0 COMISSIONING

4.1 COMMISSIONING GUIDELINES

After connecting to the electrical supply, operate the cabinet fan by pressing the rocker switch at the side of the fan/filter hood.

After the 'splash screen' appears on power-up for 10 secs. it will be replaced by the 'home screen' from where all menus / sub-menus can be selected.

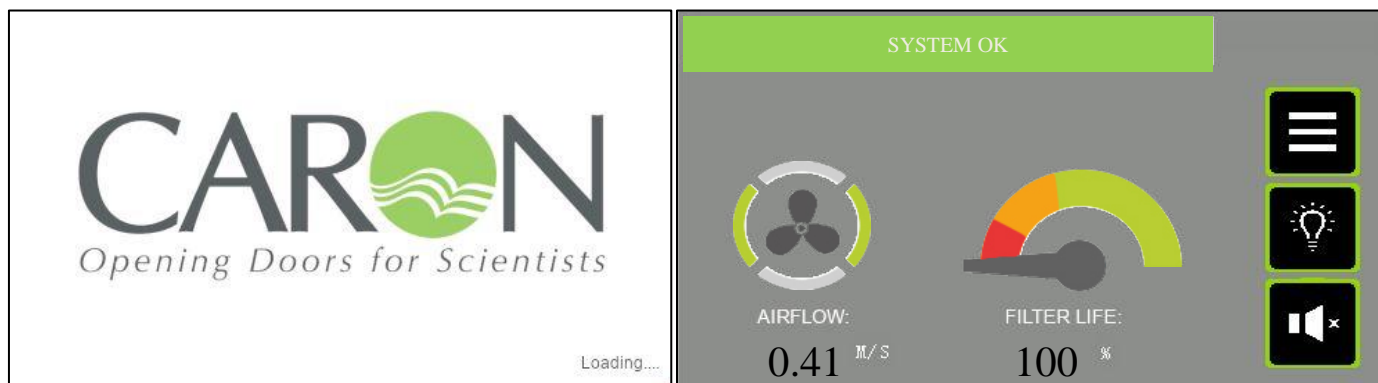

SPLASH SCREEN

HOME SCREEN

4.1.1 SETTING NORMAL AIRFLOW VELOCITY AND CALIBRATING THE TFT ALARM:

GENERAL

- For the following commissioning procedures, the cabinet should already be fitted with new chemical filters of the type suitable for capturing the chemical vapours, which will be encountered when using this cabinet and must be emptied of all labware. The bi-folding acrylic door must also be closed and both RH & LH blanking caps fitted. The internal fan should be allowed to run for several minutes in order to stabilise, after which measurements and adjustments may be made as follows:
- Face velocity measurements are used to establish that the safety cabinet continues to meet both design and industry compliance standards and that no significant deterioration in performance has occurred since previous factory acceptance tests or future servicing. It forms the basis of all subsequent testing and thorough examination protocol.
- The fan speed and alarm calibration set point have been pre-set during factory acceptance testing at a mean face velocity reference of >0.5 m/sec.
- When calibrating the inflow face velocity, take measurements at the access aperture using a rotary-vane type anemometer. Readings should be taken over a 30 second interval noting the highest and lowest values at multiple notional 'grid points' at the apertures of the acrylic front door. (Refer to Figures 2)

4.1. FIGURES 2

Figure 2
equi-spaced notional anemometer measurement grid points at
an individual open aperture to determine average airflow velocity

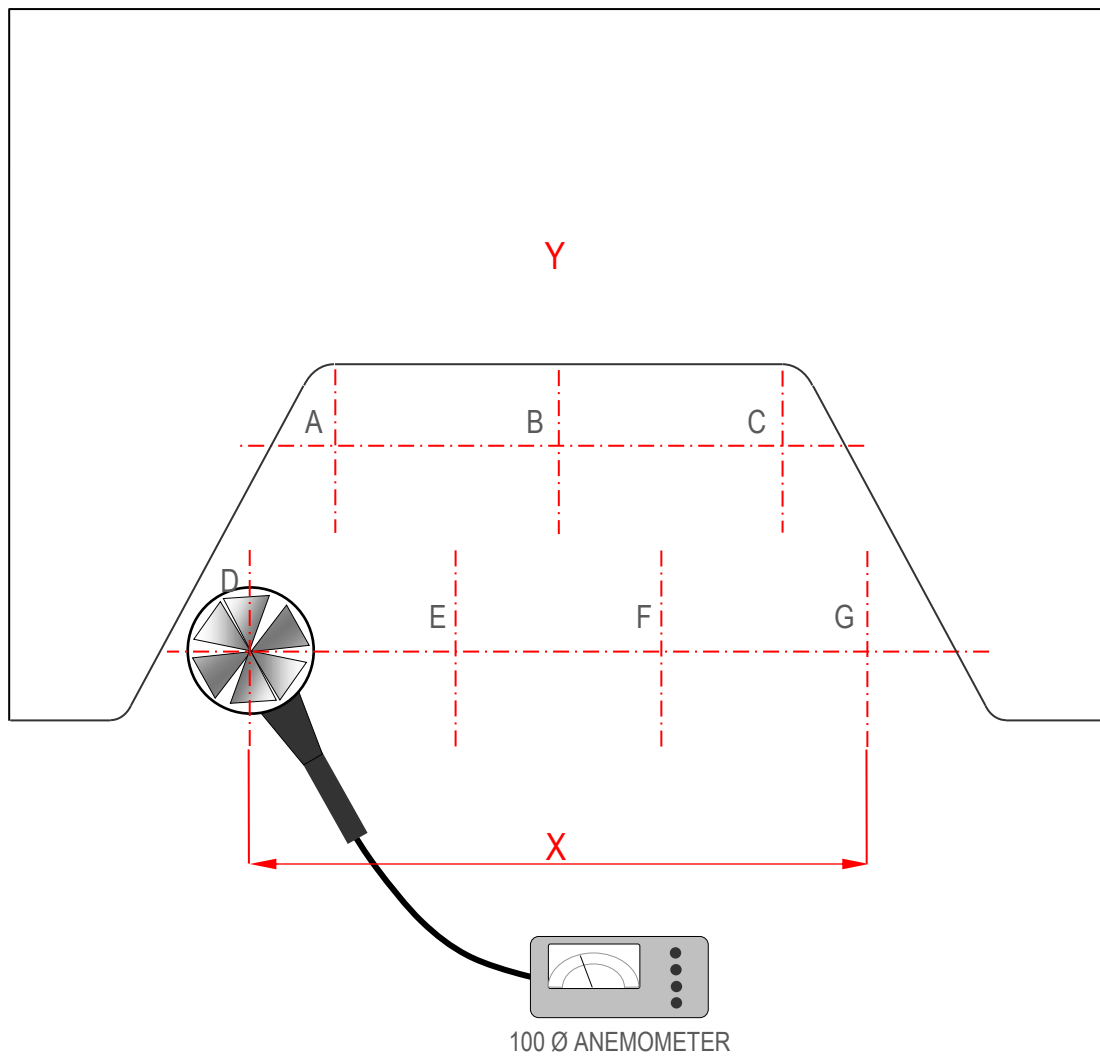

4.2 FILTER INTEGRITY TEST

There are two forms of Filter Integrity testing for these units, as standard the Carbon Filter Integrity test is used where the option has been taken for the HEPA Filters you are required to do a HEPA Filter and Seal Integrity.

4.2.1 CARBON FILTER INTEGRITY TESTING

During servicing, carbon filter integrity testing can be performed with gas detection tubes such as the Draeger™ or Gastec™. The filter is challenged with a known chemical, and the concentration of this chemical in the exhaust air is measured with a suitable detection tube.

4.2.1.1 METHOD

Ensure the cabinet is switched on and confirm airflow is correct by direct measurement and/or examination of the TFT alarm status indicators.

Introduce the chemical challenge inside the cabinet that is appropriate to that normally in use within the unit (or a less toxic equivalent Iso Propyl Alcohol IPA for test purposes)

Test the exhaust filter to confirm there is no evidence of the chemical.

If the challenge chemical is detected then the follow actions should be taken:

1. Ensure that the filter seal is undamaged and free of gaps
2. Check that the filter is fitted correctly with the seal seated and evenly compressed
3. Replace the filter and retest the cabinet

The result should be recorded in a logbook, a legal requirement under section 9 of the Control of Substances hazardous to Health (COSHH) regulations.

4.2.2 HEPA FILTER AND SEAL INTEGRITY (LEAK TEST)

This test only applies when a HEPA filter option is fitted.

The integrity of the optional HEPA filter and seal is established during factory acceptance testing in accordance with Caron Quality Standard (SOP 9.0) using the D.O.P. aerosol test method.

After installation the system should be re-tested by the installation engineer to re-confirm filter and seal integrity as follows:

The HEPA filter should be tested at normal operating airflow velocity \pm 10% using calibrated test equipment.

4.2.2.1 METHOD

The aerosol generator pipe is to be placed inside the cabinet's interior through an intake aperture, in such a way that the aerosol can be introduced into the upstream side of the filter as far from the filter as is practical to ensure adequate mixing and minimal interruption to the airflow velocity through the intake aperture.

Use the scanning probe positioned over the exhaust grille of the fan housing to determine downstream aerosol concentration levels, with separate passes made around the entire periphery of the filters, along the bond between the filter set and the enclosure frame, to confirm integrity of the seal of the filters.

Tests should be applied in accordance with SOP 9.0 and results should confirm the following:

- The photometer reading should indicate < [0.01%] penetration for leakage value
- The photometer reading should indicate < [0.005%] penetration for efficiency value

If a steady and repeatable reading on the photometer at any point exceeds the stated maximum permitted concentration, then a leak must be assumed.

Readings on the test set can be set to indicate direct percent penetration using [0.01%], [0.1%] scales as appropriate.

The average downstream concentration value shall not exceed (0.01%) of the upstream concentration measurement.

4.3 CONTAINMENT TEST

It is not practical to apply containment testing to BS EN 14175-4:2003 using SF₆ gas to this type of recirculatory fume cabinet on site, due to the safety requirement to include specific exhaust ducting and where restrictions on introducing sulphur hexafluoride in particular laboratories exist. This may prevent the application of any quantitative containment integrity testing, however, qualitative measurement of the airflow profile at the face of the cabinet, operating at the correct face velocity and in a specific room environment can be evaluated by smoke visualisation testing.

In accordance with BS EN 14175-4:2003, a smoke pencil generating a trace should be placed approx. 400mm in front of the cabinet with smoke released upwards to the ceiling. The tracer should be moved across the frontal region of the cabinet not faster than 0.2 m/s.

The airflow profile should show no evidence of escape of the tracer 'smoke' from the cabinet and a smooth and a continuous airflow pattern should exist.

There should be no evidence at any point of smoke being significantly disrupted or otherwise deflected counter to the inflow or indications of a delay in entering the aperture.

If tests show significant disturbance to the airflow profile, then room air velocity must also be checked to ensure it is not greater than 0.2m/s.

4.4 NEXTION TFT SYSTEM-OPERATOR CONTROLS

4.4.1 POWER ON/OFF

A rocker switch normally mounted on the side of the hood turn mains power ON/OFF to the control system.

4.4.2 MMI INTERFACE DISPLAY

A 4.3" TFT display is the user interface to the system. It displays the value of airflow to the enclosure, indicates alarm conditions & is used to calibrate the airflow. There are both Landscape & Portrait options.

The MMI display is a 4.3" TFT colour graphic display with touch screen control operation. It connects to the system controller PCB, and functions as a means for configuring the airflow control system, alarm indication mechanism, and status display.

4.4.3 SPLASHSCREEN

The splash screen, or power up screen, is the initial display on power up & merely displays the Caron logo. The splash screen remains for approximately 10 seconds, at which point the display should change to the HOME (Main) screen.



Loading...

4.5 OPERATION, SEQUENCE

Caron engineers will commission the normal operating condition of the enclosure, setting the parameters to suit the application. Once commissioned, the operator can safely use the cabinet. Typically, the sequence of operations is as follows:

1. Apply power to the control system via main power supply & operate the rocker switch on side of hood.
2. Observe that TFT display illuminates to the MAIN (aka HOME) display.
3. The fans are ON by default at power up.
4. Once all operating conditions are correct, the message “System OK” appears on the status object at the bottom of the MAIN screen. The airflow disc anemometer monitors the airflow (for alarm indication).
5. The airflow audible/visual alarm will annunciate if the airflow deviates above the high alarm level or below the Low alarm level parameterized in the MMI display menu system
6. Touch the MENU button to navigate to the main menu.
7. In the MENU screen, touch the FAN ON/OFF button to navigate into the fan on/off control screen. In here touch the “Fan ON” button to run the fans at setpoint speed. Touch the “Fan OFF” button to stop the fans running. Touch the “Night-mode” button to run the fans in Night-mode speed. The Fan can also be controlled by touching the fan icon on the HOME screen, to turn the fan and off.

NOTE:

On power up of the unit the audible alarm will not annunciate for the first FIVE minutes to allow the airflow to stabilise. The visual alarm on the TFT display will still be visible till the airflow has stabilised.

4.6 MAIN SCREEN

The main screen is the default display on power up, after the splash screen has been displayed for approx. 10 seconds. It is the normal operating display being presented to the user. Access to other screens is usually only for configuration.

Version with 'm/s' airflow display.

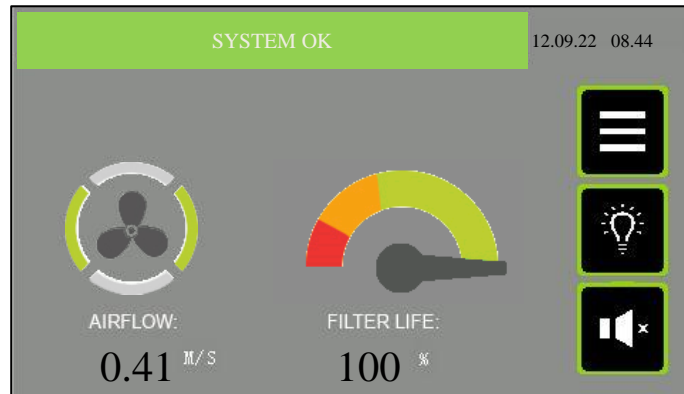

Version with air changes/hr ('Achr') airflow display.

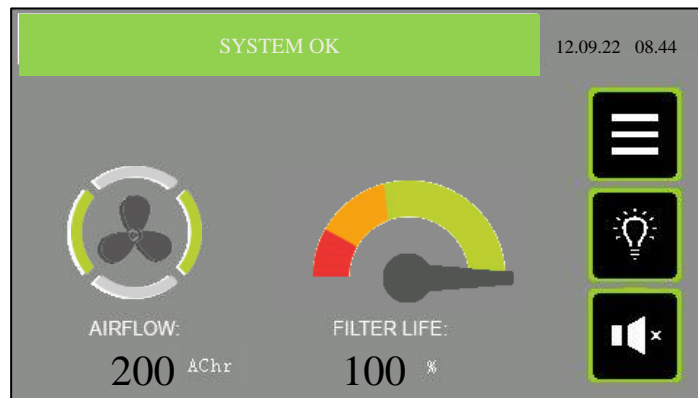

4.6.1 Airflow

This icon gives information on the idle or blowing status of the fan, and whether or not an alarm condition is present. The disc perimeter has animation and colour to give this information. The disc is stationary if the fan is off by design, and is rotating if the fan is blowing by design. The centre of this icon can be used to turn the fans on & off. Touch the fan icon to toggle the fans ON or OFF.

4.6.2 FAN ICON INFORMATION

- **STATIONARY AMBER** - Fan is OFF by design.
- **ROTATING AMBER** - Fan is ON by design, but there is a warning condition present.
- **STATIONARY RED** - Fan is OFF by design, and a critical alarm condition is present.
- **ROTATING RED** - Fan is ON by design, but there is a critical alarm condition present.
- **ROTATING GREEN** - Fan is ON by design, and there are no warning or alarm conditions present.

4.6.3 AIRFLOW VALUE DISPLAY

The airflow movement is detected by an air speed sensor anemometer mounted on the enclosure. The reading is scaled and indicated here in “m/s” to 2 decimal places. The indication, scaling and fan speed (airflow) is setup in the CALIBRATION menu. The display can also be presented in “air changes per hour” (AC/hr). The choice of ‘m/s’ or ‘AC/hr’ is made in the System Configuration screen.

4.6.4 FILTER LIFE

This gauge/dial is used as a simple way to advise the user of the time left before the next recommended service interval. It is based on calendar time from the previous service engineer visit to change filters. After the filters are freshly changed, and the engineer resets the service dates, the pointer is in the MAX green position. When the pointer is in the red zone it indicates an impending requirement for the next service visit.



4.6.5 FILTER LIFE INDICATION

The gauge graphic display is further clarified by the % of lifespan remaining before a filter change is recommended.

4.6.6 SYSTEM STATUS & ALARMS

This status text object gives the status of the system using both descriptive text & colour. It will report on any critical status affecting the normal & healthy running of the enclosure airflows. The list of status texts is as follows.



4.6.7 LIST OF STATUS TEXT

Item	Message Text	Event Description
1	SYSTEM OK	System operating within parameters
2	AIRFLOW LOW	The measured airflow is below the Low alarm level programmed in the System Configuration.
3	AIRFLOW HIGH	The measured airflow is above the High alarm level programmed in the System Configuration.
4	AIRFLOW SENSOR FAULT	The system detects a fault with the airflow sensor elements.
5	DOOR(S) OPEN	A door that is normally left closed is now open.
6	FILTER SENSOR.1 SOLVENT ALARM	Filter Saturation alarm #1 sensor is detecting solvent breakthrough.
7	FILTER SENSOR.2 SOLVENT ALARM	Filter Saturation alarm #2 sensor is detecting solvent breakthrough.
8	FILTER SENSOR.3 SOLVENT ALARM	Filter Saturation alarm #3 sensor is detecting solvent breakthrough.
9	FILTER SENSOR.4 SOLVENT ALARM	Filter Saturation alarm #4 sensor is detecting solvent breakthrough.
10	ENCLOSURE IN NIGHTMODE	The system is not running in normal mode & has been placed in night-mode (standby). The user should resume normal mode before operating the enclosure again.
11	FAN TURNED OFF	The Fan has been turned off & there is no airflow
12	FAN/FILTER TIMER EXPIRED	Self-explanatory
13	UV LAMP TIMER EXPIRED	Self-explanatory
14	ANNUAL SERVICE NOW DUE	More than 11 months have expired since the enclosure was last serviced. This status message brings this fact to the user's attention.
15	ANNUAL SERVICE NOW OVERDUE	More than 12 months have expired since the enclosure was last serviced. This status message brings this fact to the user's attention.
16	COMMUNICATION FAULT...!!!	The main control board is not communicating with the display module. Any status indication is invalid.

The status object is green when the system is OK & without any exceptions. It is amber when there is a warning and is red when there is a critical alarm present. When more than one message needs to be displayed, then they are sequentially displayed on the status banner.

4.6.8 Touch Button Functions



WHITE LIGHTING – Touch this light button to toggle the white light on and off.



MUTE – If an alarm is active & the audible is pulsing, you can touch this button to MUTE this audible sound. The audible alarm will resume again after 5 minutes if the alarm is still present. Once alarms clear (they are self-clearing), the mute condition is automatically cancelled so that a new alarm occurring will again result in an audible indication of an alarms' presence.



MENU – Press the MENU touch screen button object to exit this default (Main) display screen to the MENU list of screens.

4.7 MENU SCREEN

The menu screen consists of a list of touch buttons giving the user access to the ancillary setup & information screens on the MMI. The user accesses all screens (with the exception of the MAIN screen) via the MENU screen.

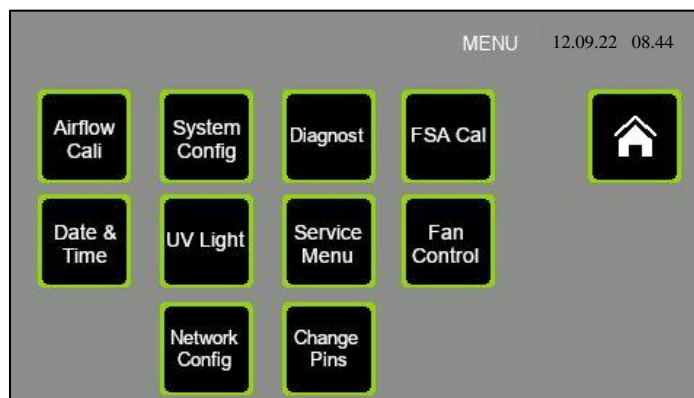

HOME– Press the Home button object to exit this display screen and return to the Main (Home) screen.

AIRFLOW CAL – Touch this touch screen button to enter the airflow CALIBRATION screen where the airflow is setup by the Caron engineer to suit the application. This screen is password protected. The password level required is ENGINEER level.

SYSTEM CONFIGURATION – Touching this touch screen button takes the user to the CONFIGURATION setup screen where the Airflow High alarm, Airflow Low alarm & Filter/UV service intervals are set by the Caron engineer to suit the application. This screen is password protected. The password level required is ENGINEER level.

DATE & TIME – Touching this touch screen button takes the user to the screen for setting the current Time & Date values that are shown on the Main screen. This screen is password protected. The password level required is SUPERVISOR level.

SERVICE MENU – Touching this touch screen button takes the user to the Service menu screen where the user has access to the service screen buttons for UV Lamp service hour counter, Filter Service hour counter, & General system service date check & reset. This screen is not password protected.

FSA CAL – Touching this touch button takes the user to the calibration screen for the system filter saturation alarm probes, if any are enabled in the Configuration screen. This screen is password protected. This screen is password protected. The password level required is ENGINEER level.

FAN CONTROL – Touching this touch screen button takes the user to the FAN on/off controls. This screen is not password protected.

DIAGNOSTIC – Touching this touch screen button takes the user to the DIAGNOSTIC screens where software data points can be viewed. This screen is really for use by a Caron engineer. This screen is not password protected.

UV LIGHT – Touching this touch screen button takes the user to the UV light control screen where the UV light ON timer value is set & the UV light is turned ON or OFF. This screen is password protected. The password level required is USER level.

NETWORK CONFIGURATION – Touching this touch screen button takes the user to the CONFIGURATION setup screen where the WIFI connections for Caron enclosures in one area. The WIFI operation is not yet implemented. This screen is password protected. The password level required is ENGINEER level.

CHANGE PINS – Touching this touch screen button takes the operator to the screen allowing him to alter the Supervisor & User levels passwords. This screen is password protected. The password level required is SUPERVISOR level.

4.8 SYSTEM CONFIGURATION SCREEN

The CONFIG screen is where the control system features are configured by the Caron engineer to suit the application. Access to this screen is password protected. The password level required is ENGINEER level.

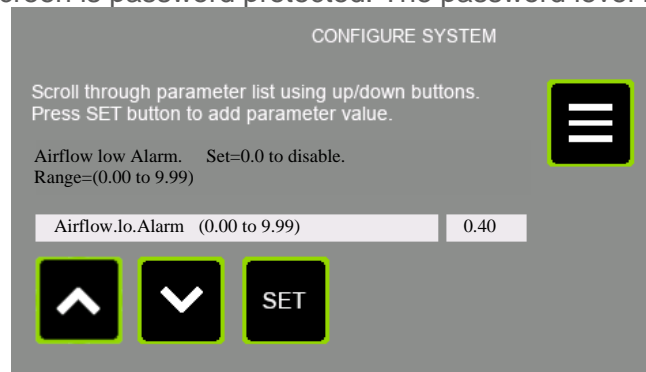

Using the scroll buttons on this page, the user can inspect & alter the value of any of the configuration parameters. You use the UP & DOWN buttons to scroll through the parameter list, and their value of each parameter is shown as you do so. Press the Set button to cause the keypad to be displayed where the parameter value can be altered.



Touch the DOWN button to move down to the next parameter in the parameter list.



Touch the UP button to move up to the previous parameter in the parameter list.



Touch this button to edit/alter the value of the currently displayed configuration parameter. You are taken to the keypad with the current value of the parameter shown. You can edit the value here & store the new value to permanent memory.



Touch the MENU to return to the Main Menu.

4.8.1 CONFIGURATION PARAMETER LIST

- **AIRFLOW LO ALARM**
Enter the low airflow value below which an audible & visual alarm indication is given via the TFT if the airflow drops below this value. Enter a value of 0.00 to deactivate this alarm. Range 0.00 – 9.99
- **AIRFLOW HI ALARM**
Enter the high airflow value above which an audible & visual alarm indication is given via the TFT if the airflow rises above this value. Enter a value of 0.00 to deactivate this alarm. Range 0.00 – 9.99
- **UV MAX HOURS**
Enter the number of hours of UV lamp ON time above which a visual indication is given via the TFT if the number of UV lamp running hours exceeds this value since the timer was last reset. Enter a value of 0 to deactivate this visual indication. Range 0 – 20000.
- **FILTER MAX HOURS**
Enter the number of hours of fan run time above which a visual indication is given via the TFT if the number of fan running hours exceeds this value since the timer was last reset. Enter a value of 0 to deactivate this visual indication. Range 0 – 20000.
- **PROPORTIONAL GAIN**
For use by the commissioning engineer. Adjust in conjunction with ‘Igain’ & ‘Dgain’ to alter the dynamic response of the fan if it needs to be adjusted. Range 0 – 9999.
- **INTEGRAL GAIN**
For use by commissioning engineer. Adjust in conjunction with ‘Pgain’ & ‘Dgain’ to alter the dynamic response of the fan if it needs to be adjusted. Range 0 – 9999.
- **DERIVATIVE GAIN**
For use by commissioning engineer. Adjust in conjunction with ‘Pgain’ & ‘Igain’ to alter the dynamic response of the fan if it needs to be adjusted. Range 0 – 9999.
- **AC/HR OR (M/S)**
Set this parameter =0 if the main display airflow indication is to be in linear air speed of m/s).
Set this parameter =1 if the main display airflow indication is to be in volumetric air changes per hour (AC/hr). Range 0 – 1.
- **AC/HR SCALER**
This parameter becomes relevant of the display mode is set for AC/Hr indication.
This is a commissioning parameter. It acts as a multiplier on the airflow indication in (m/s) to produce the display value in AC/Hr. Range 0 – 9999.
- **A/F SENSOR OFFSET**
This parameter holds the zero offset for the airflow anemometer zero airflow offset. To set this value, turn off the fan on the FAN ON/OFF display. Wait 2 minutes. Navigate to the DIAGNOSTIC display #1. From here, go to DIAGNOSTIC display #2. Read off the value of the diagnostic point “CompdaNC3”. Enter this value into the ‘A/F sensor offset’ parameter in the Configuration parameter list.
- **HOW MANY FSA SENSORS IN USE (0-4)**
This parameter “How many FSA sensors in use (0-4)” allows the user to set the number of FSA sensors for the system. Set to ‘0’ if no sensors are in use. Range 0 – 4.

4.9 AIRFLOW CALIBRATION SCREEN AND FUNCTIONS

The CALIBRATION screen is where the airflow is setup by the Caron engineer to suit the application. Access to this screen is password protected.

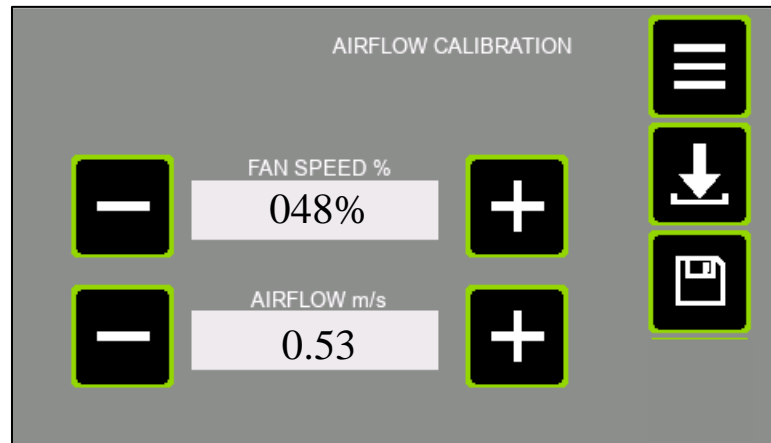

In the Calibration display, we can set the normal running airflow (fan speed) for the system when the fans(s) are started up. In the rare cases that they are useful, we can also set a NIGHTMODE speed (a much lower value than the normal running airflow), and a BACKSTOP (lower limit for VAV operation) fan speed.



Touch the (+) button to increase the value of the relevant parameter (Fan speed% or Airflow m/s).



Touch the (-) button to decrease the value of the relevant parameter (Fan speed% or Airflow m/s).



SAVE– Touch this button to save both values (Airflow fan speed & Airflow in m/s) as running setpoint values to permanent store memory.



SAVE FAN SPEED AS NIGHTMODE FAN SETPOINT– Touch this button to save the Fan speed (%) value as the Nightmode Fan speed running setpoint. The Airflow (m/s) value is ignored.



SAVE FAN SPEED AS LOWER LIMIT (BACKSTOP) TO FAN SPEED – Touch this button to save the Fan speed (%) value as the Backstop lower fan speed limit for VAV control mode. The Airflow (m/s) value is ignored.



Touch the “MENU” button to return to the MENU screen without saving any parameters if you wish to do so. So, you may have adjusted the on-screen airflow or fan speed. But if you do not touch one of the ‘Save’ buttons, then no effect is made on calibration parameters.

4.10 NORMAL AIRFLOW CALIBRATION PROCEDURE

1. Ensure system is powered up.
2. Close all doors.
3. From the Main (HOME) screen navigate to the MENU screen.
4. If calibrating the airflow for the 1st time, then you should set the “A/F sensor offset” parameter in the System Configuration before continuing here. Refer to the ‘Config Screen’ section for that procedure.
5. In the MENU screen, touch the ‘Airflow Cal’ button. You will be presented with a password entry screen.
6. Enter the user access password to enter the Airflow Calibration screen. If you enter the correct password, you will be taken to the AIRFLOW CALIBRATION screen shown above.
7. Set the cabinet door system to normal running condition, and locate a vane anemometer.
8. Using the +/- touch buttons on display corresponding to the “Fan Speed (%)”, adjust the fan speed up or down to achieve the desired airflow indication on the vane anemometer measuring airflow through the front open door’s aperture. You can hold your finger down on the + or – button to cause the fan speed to continue to change speed over time. Allow time for the fan speed to settle. Take a grid array of measurements across open doors area to determine an average value indication.
9. Then, using the +/- touch buttons on display corresponding to “Airflow (m/s)”, adjust the airflow indication (m/s) to match the aperture average reading from the hotwire probe anemometer measurements. You can hold your finger down on the + or – button to cause the airflow (m/s) value to continue to change over time. Allow time for the display value to settle. Allow time for the display value to stabilize.
10. Touch the Save button to save all calibration point parameters to permanent store memory. Also, by touching this button the system takes you out to the MENU screen.
11. Power off, and then on, system. Observe in the main display that the system eventually reaches a steady state condition where the AIRFLOW in (m/s) is the same as the value set during the calibration procedure.

4.11 SETTING UP A ‘NIGHTMODE’ (STANDBY) AIRFLOW SETPOINT

In setting the Nightmode (Standby) fan speed, the user is preparing a low energy consumption fan speed to give a significantly reduced but non-zero airflow volume for the enclosure. During this mode, the cabinet does not offer the designated level of protection, but may offer enough for a non-working mode.

- 1.Ensure system is powered up.
- 2.Close all doors.
- 3.From the Main (HOME) screen navigate to the MENU screen.
- 4.In the MENU screen, touch the ‘Airflow Cal’ button. You will be presented with a password entry screen.
- 5.Enter the user access password to enter the Airflow Calibration screen. If you enter the correct password, you will be taken to the AIRFLOW CALIBRATION screen shown above.
- 6.Set the cabinet door system to normal running condition, and locate a vane anemometer.
- 7.Using the +/- touch buttons on display corresponding to the “Fan Speed (%)”, adjust the fan speed down to a fraction of the normal operating fan speed as determined using the vane anemometer measuring airflow through the front open door’s aperture. You can hold your finger down on the + or – button to cause the fan speed to continue to change speed over time. Allow time for the fan speed to settle. Take a grid array of measurements across open doors area to determine an average value indication.
- 8.The “Airflow (m/s)” value is irrelevant, so you can ignore this value here.
- 9.Touch the Nightmode Save button to save the NIGHTMODE airflow setpoint parameter to permanent store memory. You should hear an audible tone to confirm the system is responding to your request to save the parameter.
- 10.Touch the MENU button to exit the airflow calibration screen when done.

Confirm the Nightmode setting has been properly completed by going to... **Menu** → Fan control, and toggling between OFF, ON & Nightmode control & comparing the enclosure airflow with the setpoints entered into the Airflow Calibration

4.12 FSA ALARMS

4.12.1 FSA CALIBRATION SCREEN

The FSA CALIBRATION screen is where the alarm levels for the Filter Saturation alarm sensors are setup by the Caron engineer to suit the application. Access to this screen is password protected.

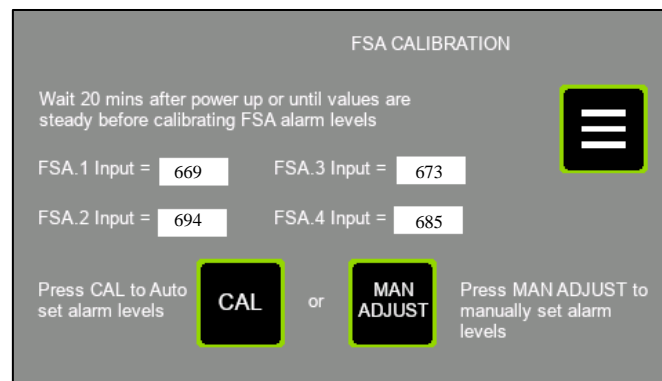

The screen shows the current sensor input of each configured FSA sensor (a maximum of 4). If there is only one enabled FSA sensor from the Configuration screen, then only one value will be shown on this display for FSA.1. The value shown next to each FSA input is the binary input to the microcontroller (range 0 to 1023). The value is shown for comparative & diagnostic purposes.



Press the MENU touch screen button object to return to the MENU list of screens.



Touch this button to take you to a Manual Adjustment screen where you can manually enter a specific alarm level value for each of up to 4-off FSA sensors.



Touch this button to cause the system to calculate 50% of each sensor input reading of the configured list of FSA sensors, and store in memory as the alarm threshold for that sensor.

4.12.2 FSA CALIBRATION PROCEDURE

1. Ensure system is powered up.
2. Navigate from HOME screen → MENU screen, and press the “FSA Cal” button.
3. Enter the required password when asked to do so, and you will be brought to the screen shown here above.
4. Allow 20 minutes for the FSA sensors to warm up, or until the values cease climbing slowly.
5. When the sensor input values finally stabilize, press the CAL button.
6. You will hear a long audible beep, and the display will revert to the MENU screen, having saved the alarm thresholds for the FSA sensors.

4.12.3 FSA ALARMS ADJUST SCREEN

The FSA ALARMS ADJUST screen is where the alarm levels for the Filter Saturation alarm sensors can have the individual sensor alarm threshold manually set to any value by the user. This is useful in cases where the automatic 50% threshold set in the FSA CALIBRATION screen needs refinement. You enter this screen via the “Man Adjust2 button in the FSA CALIBRATION screen.

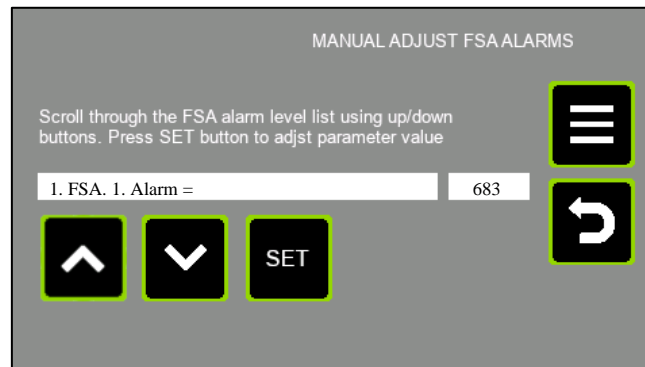

Touch the DOWN button to move down to the next parameter in the parameter list.



Touch the UP button to move up to the previous parameter in the parameter list.



Touch this button to edit/alter the value of the currently displayed configuration parameter. You are taken to the keypad with the current value of the parameter shown. You can edit the value here & store the new value to permanent memory.



Press this button to return to the FSA CALIBRATION screen.



Press this button to return to the main MENU screen. This screen shows the current sensor input of each of 4-off FSA sensor, whether they are enabled (in configuration) or not

4.12.4 FSA ALARMS ADJUST PROCEDURE

1. Ensure system is powered up.
2. Navigate to MAIN SCREEN → MENU SCREEN → FSA CAL.
3. Enter the required password when asked to do so, and you will be brought to the screen shown here above.
4. Inside the FSA CAL screen, touch the man adjust button.
5. This takes you to the FSA ALARMS ADJUST (Manual FSA Alarm levels adjustment).
6. Scroll up/down using the arrow buttons to select the desired FSA number (1 to 4)
7. Press the set button to edit/alter the value of the currently displayed FSA alarm threshold value. You are taken to the keypad with the current value of the parameter shown. You can edit the value here & store the new value to permanent memory.
8. When finished press the return button to return to the FSA calibration screen, or the menu button to return direct to the MENU screen

4.13 PASSWORDS

There are 3 password options to gain access to different levels of controlled screens:

ENGINEER (Caron personnel).
SUPERVISOR (Principal laboratory person).
USER (General enclosure operator).

The following screens are access controlled via password:

- Airflow Cal (ENGINEER level access required).
- System Config (ENGINEER level access required).
- FSA cal. (ENGINEER level access required).
- Network Config (ENGINEER level access required).
- Service Dates, in the 'Service Menu' sub menu screen. (ENGINEER level access required).
- Date & Time (SUPERVISOR level access required).
- Change Pins. (SUPERVISOR level access required).
- UV Light (USER level access required).

The system will present the password keyboard below when the password is required. Simply enter the password. A correct entry will result in passage to the destination parameter screen. The screen gives no response to an incorrect entry. It remains displaying the password keypad. As you enter the 4 characters, each digit is represented on screen by an asterisk, so the password is not shown on display.

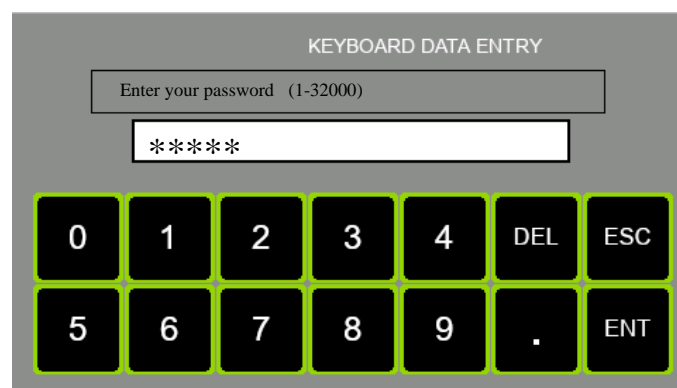

You don't have to backspace (BS) over the 4 asterisks 1st before entering the 4 digits, you simply start by pressing the 1st numerical digit in the password sequence.

DEL – “Delete”. Pressing this button deletes the character to the LHS of the cursor.

ESC – “Escape”. Pressing this button takes the data entry out of edit mode, and so the displayed value reverts to the current value of the parameter.

ENT – “Enter”. Pressing this button causes the system to evaluate the entered value for this parameter. Limits are checked. Data type is checked. If the entered value is valid then the parameter value is changed in the control system, and the non-volatile memory is updated.

[0-9 &.] – numerical & decimal point characters.

4.14 DATA ENTRY SCREEN

Several screens have within them the feature to alter parameter values. The data entry keypad screen is used for this purpose. It is the same keypad display as the password keypad display, with the exception that entered parameter characters are shown on display as you enter them.

In the data entry keypad screen, the parameter description & valid range of the parameter are shown above the data entry text box.

When you enter the parameter value, if the entered value is valid, and you press the ENT key to enter the value, then the keypad display will close & the display returns back to the parameter screen (in the Config or UV light screen). If the value being entered is invalid, then when you press the ENT key, there will be no response, the keypad screen will remain on the display.

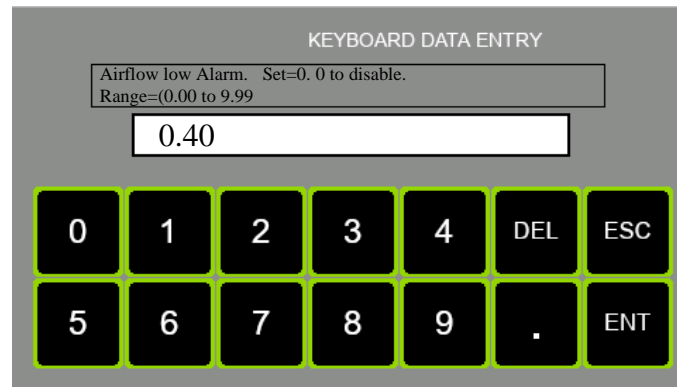

4.15 FAN ON-OFF

The FAN ON-OFF screen is where the fans can be turned on and off. At power up, the fans are default to the OFF state. You must access this screen to turn the fans on or off, or, simply touch the fan icon in the centre of the Home screen. The screen is not password protected.

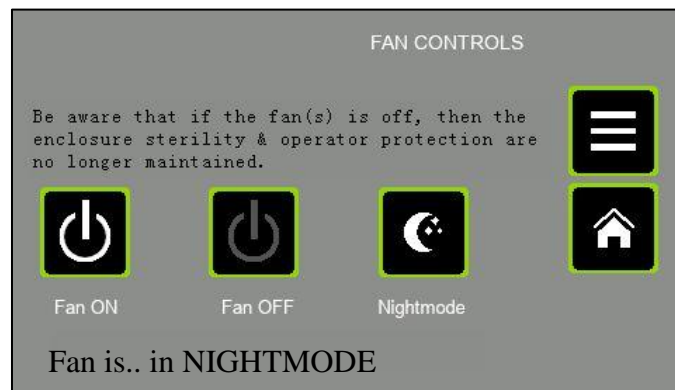

Press this button to Turn the fans ON, and run at normal setpoint. Observe the status message changes to “Fan is..ON”.



Press this button to Turn the fans OFF. Observe the status message changes to “Fan is OFF”.



Press this button to Turn the fans to Nightmode speed. Observe the status message changes to “Fan is: in NIGHTMODE”. See the chapter on Airflow Calibration for a description of what Nightmode means, and how it is setup.



Press this button to return to the main MENU screen.



Press the Home button to return to the Main (Home) screen.

4.16 DATE AND TIME

The DATE & TIME screen is where you can set the current Time & Date used for display on the Main screen. It is also used for tracking the general Service intervals & indicating this on the Main screen.

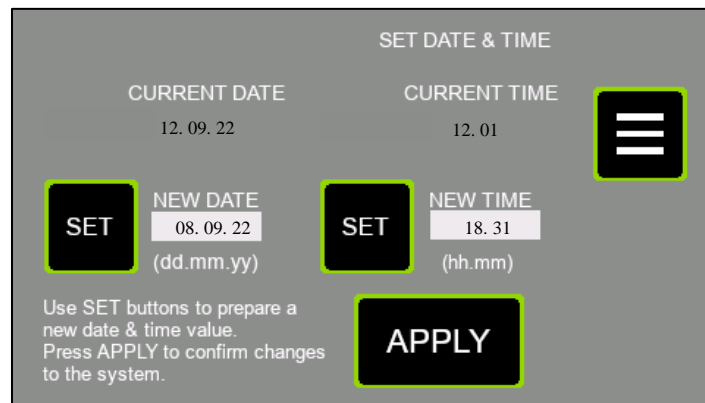

SET (New Date) – Touch this button to edit/alter the value of the preparation value for “New Date.” You are taken to the keypad with the current value of the parameter shown. You can edit the value here. The value is only temporarily stored. It is only when you press the “Apply New Date/Time” button that the prepared new date & new time are stored to permanent memory.



SET (New Time) – Touch this button to edit/alter the value of the preparation value for “New Time.” You are taken to the keypad with the current value of the parameter shown. You can edit the value here. The value is only temporarily stored. It is only when you press the “Apply New Date/Time” button that the prepared new date & new time are stored to permanent memory.



APPLY NEW DATE/TIME – Touch this button to store the prepared new date & new time to permanent memory. You should first prepare a new date & time for the next ‘minute’ value rollover. Then press the apply new date/time button as soon as the time reference rolls over.



Press this button to return to the main MENU screen.

4.17 UV

This section will detail the controls and operation of the UV Light option of the unit.

4.17.1 UV CONTROL SCREEN

The UV Control screen allows the user to turn the UV light on/off & decide the time for which the light should be energized.

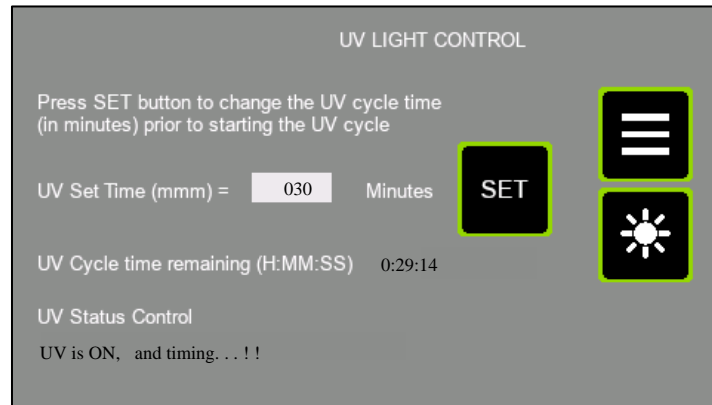

Press this button to return to the main MENU screen. If the UV light is on, then it will turn off, and the white lighting will resume previous status (on or off) at the point the UV was activated.



Touch this button to set the UV “on” time duration. If you press it, you are taken to the data entry keypad where you can enter a UV on time duration range of 0-120 minutes. The entered value is retained in permanent memory & so is still retained even after a power cycle.



This touch screen object is used by the operator to turn the enclosure UV lights on or off. It is a toggle button so the UV lights will alternate on & off as the button is repeatedly touched. When the UV turns on, the white lights will turn off.

4.17.2 UV CONTROL STATUS MESSAGE

UV CYCLE TIME REMAINING – This indicator shows the time left in the activated UV cycle in the format HH:MM:SS.

UV Control Status Message

This text object gives the status of the UV light control cycle, and information regarding the door switch if relevant. The display texts are as follows:

UV OFF, Door Open This tells us that the UV lamp is off, and it is not ready to be turned on, as the door is open.

UV OFF, Ready This tells us that the UV lamp is off, and it is ready to be turned on, as the door is properly closed.

UV ON, Timing - This tells us that the UV cycle is running, and it is timing down. The door is clearly closed as otherwise, the cycle would be interrupted.

UV ON, Cycle Ending -This tells us that the UV cycle is running, and it is timing down. Also, as it is in the 'Cycle Ending' phase it means there is less than 10 seconds to go before the UV cycle is completed. During this phase also, the audible buzzer is pulsed once per second. The door is clearly closed as otherwise, the cycle would be interrupted.

If the UV cycle is interrupted either by the door opening or the user toggling the UV button, then the system remains on the UV control screen & the fans come back up. If on the other hand a UV cycle is allowed to complete naturally, then the display reverts to the MAIN screen & the fans come up. The white lights will resume previous state of on or off.

4.17.3 PROCEDURE FOR ACTIVATING THE UV CYCLE

Sequence to activate the UV control...

1. Ensure system is powered up.
2. Close all hinged doors.
3. Navigate to the UV LIGHT control screen via the Main MENU screen.
4. Check the value of the UV.SET.TIME in minutes. If the value is OK then go to step 6, else press the SET button.
5. This takes you to the keypad display. Enter the required UV on time in minutes (range = 0-120 minutes). If the entered value is OK, the system takes you back to the UV control screen.
6. Inspect the UV status text at the bottom of the UV CONTROL screen. it must read "UV OFF, Ready!!" before the UV is ready to start. Rectify any issue with the door switch of it reads "UV OFF, Door Open!!"
7. Touch the UV button to start the UV cycle.
8. Notice the white lights turn OFF (if they were on), the fan turns off (if it was on) & the UV lights turn on.

4.17.4 UV SWITCH OFF MODES

1. The UV lights will remain on until either...
 - a) The preselected UV timer has expired.
 - b) The front horizontal hinged door is opened.
 - c) The user touches the UV button on the TFT display

2. If the UV cycle has not yet completed but you want to interrupt it, then touch the UV button on the UV CONTROL display (or open the door to break the door switch sensing). You should notice that the white come back on (if they were energized prior to engaging the UV lights). Also, the fans come back on (if they were energized prior to engaging the UV lights). You can navigate back to the MAIN display via MENU→ HOME.

If the UV cycle is allowed to complete, the UV lights switch off. You should notice that the MMI display reverts to the Main screen & the fans start back up on if they were on before UV cycle was started. Also, the white come back on (if they were energized prior to engaging the UV lights).

PART 2 - OPERATING THE CHEMCAP PRO2 CABINET

5.0 OPERATING THE CHEMCAP PRO2 CABINET

The PRO2 cabinet must have been installed and commissioned in accordance with 4.0 Commissioning of this manual before attempting to operate.

5.1 To Operate the Cabinet:

- 1) With the mains supply on, press the rocker switch at the side of the fan hood.
- 2) Observe that TFT display illuminates to the MAIN (aka HOME) display.
- 3) Once all operating conditions are correct, the message "System OK" appears on the status object at the bottom of the MAIN screen.

The fan speed will quickly stabilise at the level pre-set during commissioning, however, during this period the control system will visually alarm until the airflow velocity has reached the calibrated setting. Allow sufficient time for the airflow velocity to stabilise throughout the interior before carrying out any processing.

The level of containment protection afforded by the fume cabinet is affected by the manner in which it is used. The cabinet provides the primary barrier and will contain the hazard source but must be used as part of a comprehensive laboratory safety routine.

5.2 Good Laboratory Practice

Good Practice Should Include the Following:

- Adequate planning and understanding the function of the cabinet.
- Keep the front aperture free from obstruction by apparatus or containers.
- Ensure that both RH and LH port blanking caps are securely inserted in the enclosure
- Limit the amount of chemicals and labware within the acrylic enclosure during procedures where possible
- Close and secure the bi-folding front panels during operation.
- Do not lift the bi-folding front panels except where necessary for apparatus set up. The front panels should always be closed and secured by the catches during use of the enclosure. This ensures the airflow velocity remains at the pre-set safe level. In addition, it serves as a protective shield and helps protect the user from hazardous or highly reactive materials.

NOTE:

- *The product is not designed or certified to Directive 2014/34/EU (Atex) 240V models, or Directive 94/9/EC (Atex) 115V models, or use in a potentially explosive atmosphere.*
- *It is not designed for use where toxic substances above OHC3 category may be used.*
- *There are no direct sources of ignition within the working zone of the cabinet and no risk of fire or explosion during what is considered normal use. However, in the event of fire caused by the actual process atmosphere and where the end-user may introduce an ignition source, it will provide only short-term initial containment.*
- *It should not be relied upon to provide absolute protection and you should evacuate the laboratory/room according to your current fire regulations.*
- *If it is safe to do so, switch the fan off promptly; this may help to prevent fan-assisted airflow aiding further combustion.*
- Access to the cabinet interior during processing should be confined to the aperture in the hinged front panel; otherwise, the airflow and containment integrity will be affected.
- In the event of a significant disturbance to the incoming airflow during use the airflow alarm monitor will activate, however, this will cease as soon as the airflow velocity is allowed to return to pre-set levels.
- When installing or removing labware, the complete front bi-folding acrylic panel can be hinged upwards for full access to the enclosure. This panel should be secured for safety and convenience by aligning the access aperture in the panel and ‘hooking’ over the retaining tabs fitted on top of the fan housing
- Do not switch the cabinet off during processing operations and allow 15 minutes *after* operations cease before switching off the fan.

PART 3 - SERVICE MENUS

6.0 SERVICE MENUS (sub menu)

This screen is a menu of service-related functions for the enclosure. The UV lamp & Filter Timer check operations are observed in here. The annual service interval can be reset & adjusted in here by the Service engineer.

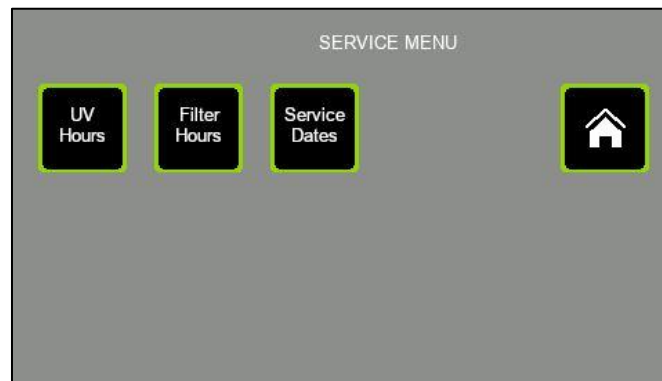

UV HOURS – Touch this button to inspect the duration of operation of the UV Lamps, and reset the timer if desired. The button takes you to the screen titled “UV SERVICE CHECK.”

FILTER HOURS – Touch this button to inspect the duration of operation of the Filters, and reset the timer if desired. The button takes you to the screen titled “FILTER SERVICE CHECK.”

SERVICE DATES – Touch this button to inspect the next general service date, and reset to the next date if the service engineer has just completed a service operation. This screen is password protected. The password level required is ENGINEER level.



Press the Home button to return to the Main (Home) screen.

6.1 FILTER HOURS RUN SCREEN

This screen gives the values of Filter actual running hours & maximum allowed (before visual alarm indication) running time (in hours) to the user. This information can be used to determine whether the filters need changing. The value 'Filter hours usage alarm setpoint' is set in the CONFIG menu where the parameters are access restricted using a password. There the parameter is called "filter Max Hours".



6.1.1 Filter Hours Run

This register indicates the accumulated running time of the enclosure as an indication of when the Filter should be considered for testing or replacement. The accumulated 'Filter hours run' value is compared with the setup 'Filter hours usage alarm setpoint' time. If the 'Filter hours run' exceeds the setpoint time, then a visual alarm condition is generated & is displayed in the status message area on the MAIN display. There is no audible alarm for this exception, but the message is clearly displayed like any other alarm on the system status object on the MAIN display. It does not prevent use of the enclosure. You can clear the accumulated hours to stop the nuisance of the alarm as follows:

- 1) Navigate to this "Filter Hours run check" screen using the path:
MENU → SERVICE MENU → FILTER HOURS
- 2) Touch the RESET button underneath the text "Filter Hours Run."
- 3) Observe that the Filter Hours Run resets to 00000.



Press this button to return to the main MENU screen.



Touch this button to return to the Service Menu screen

6.2 UV HOURS SCREEN

This screen gives the values of UV Lamp actual running hours & maximum allowed (before visual alarm indication) running time (in hours) to the user. This information is used to determine whether the efficacy of the UV lamp is likely to be reduced because of its age & running time. The value 'UV Lamp hours usage alarm setpoint' is set in the CONFIG menu where the parameters are access restricted using a password. There it is called 'UV Max Hours'.

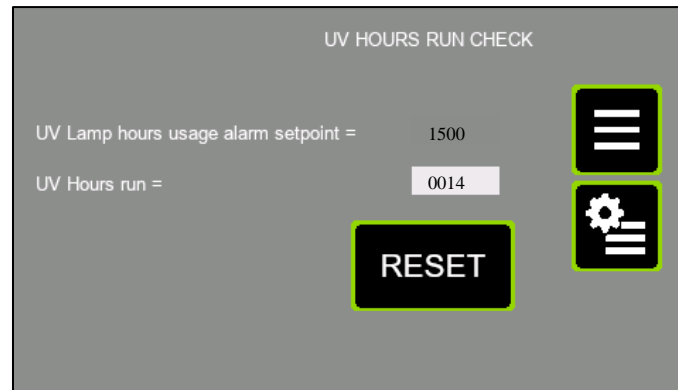

6.2.1 UV HOURS RUN

This register indicates the accumulated running time of the UV lamps in the enclosure as an indication of when the lamps should be considered for testing or replacement. The accumulated 'UV hours run' value is compared with the setup 'UV Lamp hours usage alarm setpoint' time. If the UV lamp run hours (UV hours run) exceeds the setpoint time, then a visual alarm condition is generated & is displayed in the status message area on the MAIN display. There is no audible alarm for this exception, but the message is clearly displayed like any other alarm on the system status object on the MAIN display. It does not prevent use of the enclosure. You can clear the accumulated hours to stop the nuisance of the alarm as follows:

- 1) Navigate to this "UV Hours run check" screen using the path:
MENU → SERVICE MENU → UV HOURS
- 2) Touch the RESET button underneath the text "UV.HRS.RUN".
- 3) Observe that the UV Hours Run resets to 00000.



Press this button to return to the main MENU screen.



Touch this button to return to the Service Menu screen..

6.3 ANNUAL SERVICE DATES

This screen allows you to reset the service due & overdue dates for next year's general service. The Auto Reset function always sets the dates for one year ahead of today's current date.

The warning date is 11 months from the current date and the overdue date is 12 months from the current date.

When the warning date is reached then a visual alarm is generated on the main screen with a message to "Annual Service Now Due!". No audible alarm is produced as a result of this event.

When the overdue date is reached then a visual alarm is generated on the main screen with a message to "Annual Service OverDue!". No audible alarm is produced as a result of this event.

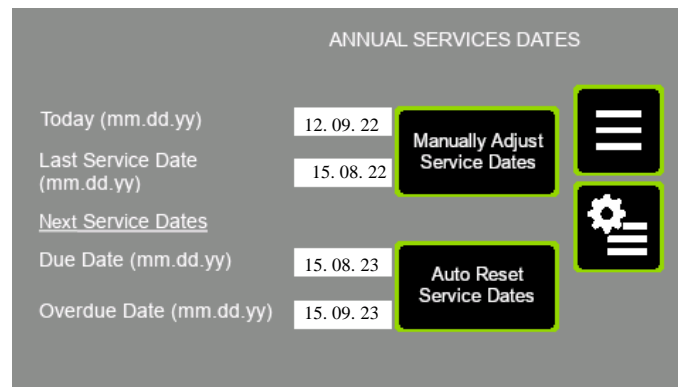

Touch this button to advance the Service Due & overdue dates one year ahead of today's date. The warning date is 11 months from the current date & the overdue date is 12 months from the current date. The new Service Overdue date & Due Date are both updated into permanent memory.

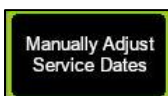

Touch this button to navigate to the 'Manual Service Date Adjustment' screen, where you can decide on what date the next 'overdue' service date lies. The system calculates the 'service due' date as one month less than that.



Press this button to return to the main MENU screen.



Touch this button to return to the Service Menu screen.

6.3.1 MANUAL SERVICE DATE ADJUSTMENT

This screen allows you to manually decide when the next service due & overdue dates occur. The Auto reset function in the preceding screen always sets the dates for one year ahead of today's current date. The warning date is 11 months from the current date & the overdue date is 12 months from the current date.

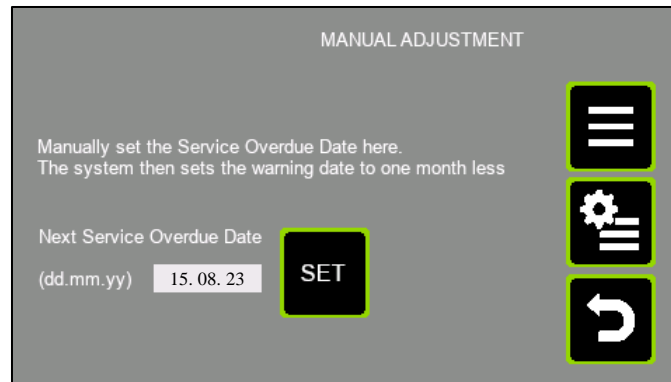

Touch this button to edit/alter the value of the preparation value for "Next Service Overdue Date." You are taken to the keypad with the current value of the parameter shown. You can edit the value here. The new Service Overdue date & Due Date are both stored to permanent memory.



Press this button to return to the main MENU screen.



Touch this button to return to the Service Menu screen.



Press this button to return to the previous screen (Annual Service Dates)..

6.4 NETWORK SCREEN

6.4.1 NETWORK SCREEN 1

This screen allows you to set the 1st & 2nd IP address octet for the IP address of this cabinet on the WiFi addressing system.

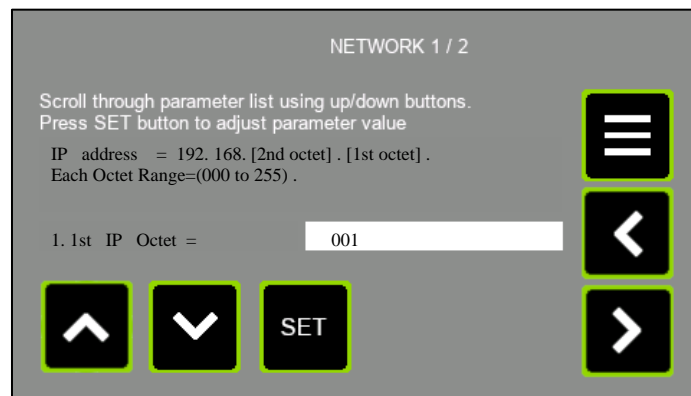

6.4.2 NETWORK #2 SCREEN

This screen allows you to set ...

- The email address for alarm alters.
- The WiFi SSID address.
- The WiFi password.

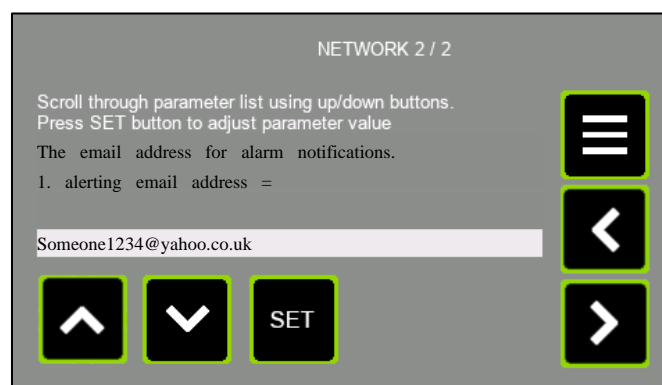

6.5 Alpha Numeric Keyboard screen

This screen is used when entering data requiring alphanumeric input. For this TFT, that is some of the WiFi Network parameters.

Normal alphanumeric screen:

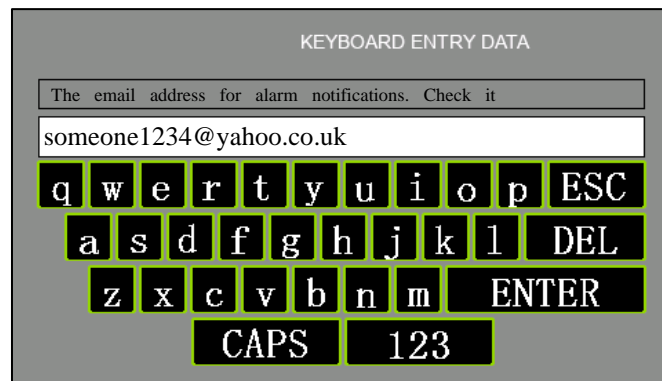

Touch the CAPS button & you get this...

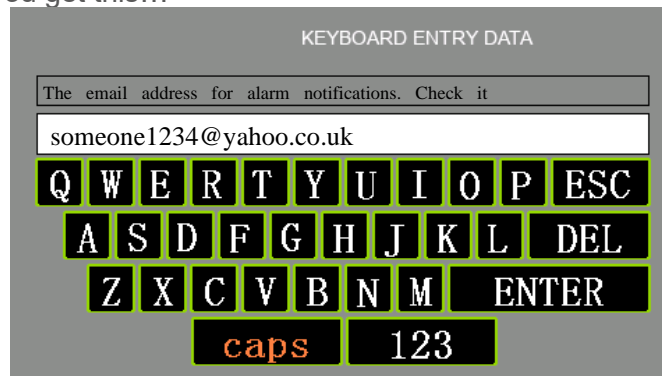

Touch the 123 button and you get this...

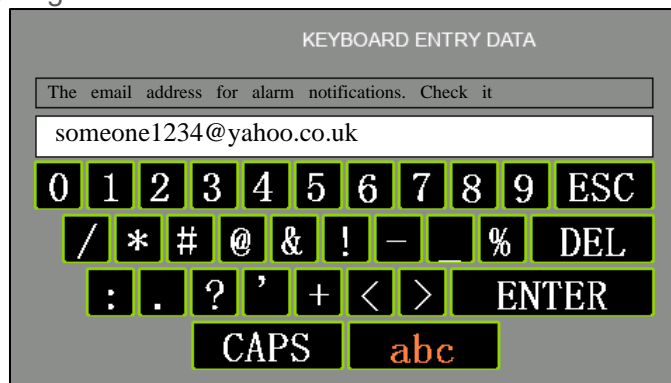

6.6 DIAGNOSTIC SCREENS

The diagnostic screens are for use by Caron engineers in inspecting the operation of the system. However, the screens are not password protected, and so can be accessed by anyone.

6.6.1 DIAGNOSTIC SCREEN #1

DIAGNOSTIC DATA #1			
ANC3_IN =	578	FBScaler =	2133
AND0_IN =	339	ANIN1 (PL4) =	450
AmbTempC =	23.8	ANIN2 (PL5) =	478
TempScaler =	2489	Digital In =	00000001
AirFlow =	0.51	Digital Out =	00000001

ANC3 IN This is the uncompensated analogue signal input value from the airflow anemometer 'hotwire' thermistor. It can be used to determine what value to enter for the 'A/f sensor offset' in the CONFIGURATION parameters.

AND0 IN This is the analogue signal input value from the ambient temperature thermistor inside the airflow anemometer.

AmbTempC This is the ambient temperature as measured using the thermistor inside the airflow anemometer.

TempScaler This is an internal scaler used in airflow calculations generated from the ambient temperature signal.

Airflow The airflow in m/s. it is the same value that is shown on main display.

FBScaler The value of the scaler generated in the Calibration screen when setting the airflow display value using +/- buttons.

ANIN.1 (PL4) This is the analogue input signal value into PL4 connector of the main control board. The signal is a 0 to 10V input.

ANIN.2 (PL5) This is the analogue input signal value into PL5 connector of the main control board. The signal is a 0 to 10V input.

DIGITAL IN This is the binary expression of all 5 digital inputs to the PL3 connector of the main control board.

1. Bit.0 status (1 or 0) = input #1 on PL3-pin.3.
2. Bit.1 status (1 or 0) = input #2 on PL3-pin.4.
3. Bit.2 status (1 or 0) = input #3 on PL3-pin.5.
4. Bit.3 status (1 or 0) = input #4 on PL3-pin.6.
5. Bit.4 status (1 or 0) = input #5 on PL3-pin.7.
6. All other bits are not used.

DIGITAL OUT This is the binary expression of all 5 digital outputs from the MCU in the main control board.

1. Bit.0 status (1 or 0) = WhiteLightOutput, output on PL2-pin.3.
2. Bit.1 status (1 or 0) = UVLightOutput, output on PL2-pin.4.
3. Bit.2 status (1 or 0) = AlarmStatusOutput, output on PL2-pin.5.
4. Bit.3 status (1 or 0) = Aux_Relay1 (unassigned), output on PL2-pin.6.
5. Bit.4 status (1 or 0) = Aux_Relay2 (unassigned), output on PL2-pin.7.
6. Bit.5 status (1 or 0) = Output to Buzzer on PCB.
7. All other bits are not used

6.6.2 DIAGNOSTIC SCREEN #2

DIAGNOSTIC DATA #2	
Nightmode Out% = 21.7	CompdaNC3 = 510
Backstop Out% = 0	A01% (PL8) = 45.8
AND1_IN =	A02% (PL9) =
AND2_IN =	AOutput% = 45.8
ANIN3 (PL10) = 0007	ANIN4 (PL11) = 0007

Nightmode Out% This is the % of maximum speed that will be output to the fan, when running in Nightmode (standby mode). The setpoint is configured in the Airflow Calibration screen.

Backstop Out% This is the % of maximum speed that will act as a lower limit speed to the fan, when in VAV mode, and the fan wants to reduce speed to achieve the setpoint airflow. The setpoint is configured in the Airflow Calibration screen.

AND1_IN This is the hotwire input to the 2nd unused airflow sensor interface. Observe no data is displayed here.

AND2_IN This is the ambient temperature input to the 2nd unused airflow sensor interface. Observe no data is displayed here.

ANIN3 (PL10) This is the analogue input signal value to the a general purpose 0..10VDC analogue input port on PL10 on the main control board.

CompdaNC3 This is the compensated version of the hotwire signal. It can be used to set the “A/F sensor offset” in the system Configuration.

A01% This is the % of maximum 10V analogue output appearing now on PL8.

A02% This is the % of maximum 10V analogue output appearing now on PL9.

AOutput% This is the % of maximum 10V analogue output to the fan or fan speed controller.

ANIN4 (PL11) This is the analogue input signal value to the a general purpose 0..10VDC analogue input port on PL11 on the main control board.

6.6.3 DIAGNOSTIC SCREEN #3

DIAGNOSTIC DATA #3			
FSA. 1. IN (PL10)	0499	FSA. 1 ALARM. LEVEL	0250
FSA. 2. IN (PL11)	0457	FSA. 2 ALARM. LEVEL	0250
FSA. 3. IN (PL4)	0007	FSA. 3 ALARM. LEVEL	0007
FSA. 4. IN (PL5)	0007	FSA. 4 ALARM. LEVEL	0007

FSA.1.IN (PL10) This is the analogue input signal value from the Filter Saturation sensor connected to PL10 of the main control board.

FSA.2.IN (PL11) This is the analogue input signal value from the Filter Saturation sensor connected to PL11 of the main control board.

FSA.3.IN (PL4) This is the analogue input signal value from the Filter Saturation sensor connected to PL4 of the main control board. A Filter Saturation Alarm sensor connected to PL4 requires the use of a BN5001 interface module.

FSA.4.IN (PL5) This is the analogue input signal value from the Filter Saturation sensor connected to PL5 of the main control board. A Filter Saturation Alarm sensor connected to PL5 requires the use of a BN5001 interface module.

FSA.1.Alarm Level This is the currently operating alarm threshold for the FSA #1 input sensor. It only applies if the alarm is enables. When the FSA.1.IN value drops below this value an audible & visual alarm is triggered.

FSA.2.Alarm Level This is the currently operating alarm threshold for the FSA #2 input sensor. It only applies if the alarm is enables. When the FSA.2.IN value drops below this value an audible & visual alarm is triggered.

FSA.3.Alarm Level This is the currently operating alarm threshold for the FSA #3 input sensor. It only applies if the alarm is enables. When the FSA.3.IN value drops below this value an audible & visual alarm is triggered.

FSA.4.Alarm Level This is the currently operating alarm threshold for the FSA #4 input sensor. It only applies if the alarm is enables. When the FSA.4.IN value drops below this value an audible & visual alarm is triggered.

6.6.4 DIAGNOSTIC SCREEN #4

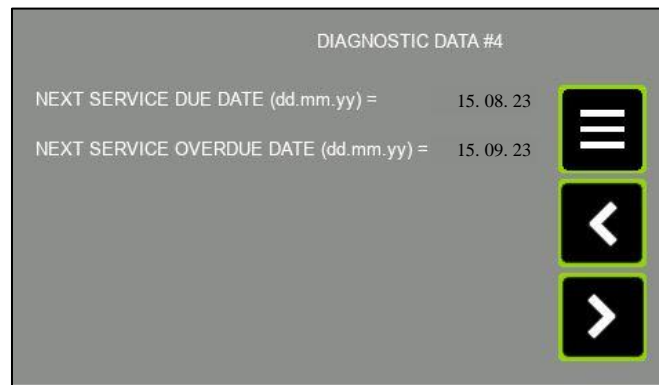

Next Service Due Date This is the next date that a “service now due” warning message will issued on the MAIN screen to the user.

Next Service Overdue Date This is the next date that a “service overdue” warning message will issued on the MAIN screen to the user.

6.7 USER PINS SCREEN

The User PINS screen can be used to alter the access password for the SUPERVISOR and the USER. However, only the ENGINEER & SUPERVISOR can access this screen to change the passwords. The SUPERVISOR & ENGINEER can change both the SUPERVISOR & the USER passwords. The USER has no access in here.

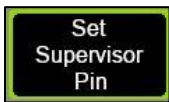
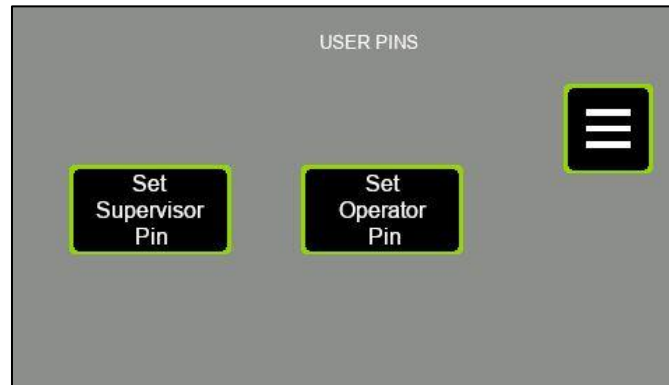

Touch this button to alter the SUPERVISOR password.



Touch this button to alter the USER (operator) password.



Press this button to return to the main MENU screen.

PART 4 -PREVENTIVE MAINTENANCE

7.0 EXAMINATION & TESTING

7.1 Statutory Examination, Testing and Preventative Maintenance-General

This fume cabinet is subject to statutory examination and testing under current COSHH 2002 regulations for LEV systems-the interval between examinations must not exceed 14 months.

This requirement, placed upon all employers who install fume cabinets in their workplace, is fully supported throughout the intervening period by the automatic detection and recording of the following parameters:

- a) Filter life dial-indicator, based on calendar time set by the service engineer during the previous visit. It also shows remaining filter lifespan as a % value. 
- b) “Annual Service Now Due” and “Annual Service Overdue” screens/alarms are presented.
- c) Filter saturation alarm (FSA) monitoring and annunciation.
- d) After each examination and service filter replacement, the dates should be recorded in a suitable Log Book maintained by the end-user. Caron can provide an appropriate log book to end-users on request.
- e) A ‘PASSED’ test label must be affixed by the examiner to the exterior of the cabinet to clearly indicate that the cabinet has passed test and inspection. Otherwise, in the event of a fault where the repair required cannot be completed at the time of the test a ‘FAILED’ test label must be affixed to clearly indicate to operators and supervisors that the cabinet cannot be used until remedied.

7.2 FACE VELOCITY

The Nextion TFT alarm system will continuously monitor the face velocity and both audibly and visually announce an alarm when the value falls below the preset level. This will also occur when the lower visor panel is opened during operation of the cabinet.

7.3 FILTER CONTAINMENT BREAKTHROUGH

When measurement of the sampling port reveals a breakthrough of contaminant, the Enviro chemical filter must be replaced. Change out procedures involves discarding the original main filter and replacing with the back-up chemical filter where it will become the main filter.

The new (replacement) filter becomes the back-up filter until the next service change occurs.

It is recommended that the backup filter be also tested for potential breakthrough by sampling with an appropriate Draeger™ or Gastec™ tube taking measurements of the exhaust airflow before refitting as the main filter.

Warning: *The original (stage 2) contaminated main chemical filter must never be refitted (particularly as a back-up) since significant breakthrough has already occurred and airflow will transport the contaminants out into the room/laboratory air.*

7.4 CARBON FILTER CHANGE PERIOD-GUIDANCE

Chemcap Enviro™ carbon filters have retention capacities, which exceed those of many other filter manufacturers; long life under normal use is highly achievable for these products.

It should be understood that when new filters are removed from their packaging, they soon begin to adsorb vapours and moisture from their immediate environment.

This has minimal effect on the performance of a filter in the short to medium term, but is clearly important particularly where filters are being used for very harmful challenges, such as formaldehyde.

7.5 ELECTRICAL SAFETY

7.5.1 For 230V Units:

This safety cabinet must continue to meet the requirements of the Electricity at Work Regulations 1989 and conformity assessment to BS EN 61010 Safety Requirements-Electrical equipment for laboratories

The correct fuse must be fitted to the mains plug at all times and the mains lead should be examined frequently for signs of damage.

There should be regular formal inspections carried out by a 'competent person' and must include earth bonding and insulation tests. All inspections carried out should be recorded.

7.5.2 For 115V Units:

The product must continue to meet the requirements of NEC 2008 with the correct fuse fitted -the mains lead should be examined frequently for signs of damage.

There should be regular formal inspections carried out by a 'competent person' and must include earth bonding and insulation tests. All inspections carried out should be recorded.

7.6 UV SAFETY

UV Safety is for units fitted with the UV light option.

UVc wavelength penetration can cause damage to eyes and skin where exposure to UVc radiation is prolonged. Reflective capabilities are high.

It should also be recognised that UV light can damage plastics and rubber-based materials which may be used within the cabinet and this may lead to secondary hazards such as leaking tubing or containers, over continuous periods.

Due to the employment of special glass, the lamp does not generate ozone.

7.5.1 UV Lamp Life Expectancy-general

The lamp has a rated life of 8,000 hours maintaining an effective intensity for 6,000 hours, after which the UVc output will fall to less than 80% power relative to a new lamp.

Irradiation time will need to be increased to achieve same levels of UVc sterilisation.

A record of UVc usage is recorded by the Nextion TFT system so that accumulated hours can be determined and the point from which an increase in UVC duration or lamp replacement may be required.

8.0 PREVENTATIVE MAINTENANCE

Regular maintenance and statutory testing is essential to the proper functioning of this safety cabinet and we strongly advise entrusting this to trained personnel who are technically competent and equipped with suitable calibrated instruments.

8.0.1 HEALTH AND SAFETY RESPONSIBILITIES



- a) When carrying out servicing or preventive maintenance to this cabinet you are responsible for both yourself and others in the local vicinity for Health & Safety, as the product can potentially cause danger through exposure to hazardous voltages, manual handling injuries and contact with high torque rotating fans.
- b) Service engineers must comply with all customer on-site safety regulations and obtain the necessary Work Permits before carrying out any of the tasks required by this document.
- c) Processes being carried out in the Chemcap Pro2 cabinet must be halted and any ancillary equipment should be removed to avoid contamination or damage during the servicing/repair tasks.
- d) Appropriate PPE (which includes overalls, protective gloves, FFP3 grade facemask and safety glasses) should be worn at all times.



8.0.2 TEST EQUIPMENT

The following calibrated test equipment will be required to validate the cabinet on site:

- PAT tester (approved type BETAPAT M2140 or M2141)
- 100 Ø Rotary vane type anemometer calibrated type (type Airflow LC6000)
- DOP test set (Calibrated) comprising: TEC Services Model PH-3 or ATI 2GA series photometer,
- A validated aerosol smoke generator, generating a polydisperse aerosol.
(Approved types C.F. Taylor or Concept Vi-count)

8.1 CLEANING AND CLEANLINESS STANDARD

8.1.1 DAILY

Using a damp cloth, clean the exterior surfaces of the cabinet, regularly, particularly the front and side surfaces, to remove accumulated dust.

8.1.2 WEEKLY

Thoroughly surface-decontaminate the work surface using ethanol/propan-2-ol such as Micronclean (or other approved disinfectant).

The recommended method of cleaning the acrylic surfaces is by damp wiping with diluted detergent and water.

IMPORTANT: DO NOT USE SOLVENT-BASED CLEANING SOLUTIONS, AS THIS MAY PROMOTE STRESS CRACKING OF THE ACRYLIC MATERIAL.

8.2 CHANGING THE PRE-FILTERS

The particle pre-filter is the first-line of defence and will therefore be contaminated with particles from the range of substances processed within the enclosure. It requires changing regularly to ensure proper airflow and to ensure long life of the main filter.

The frequency of changing depends on the environment. It can vary from a week in exceptionally dusty conditions to 6 months or more in a clean environment. Pre-filters should ideally be replaced at each service visit.

8.2.1 PROCEDURE FOR SAFE-CHANGE REMOVAL, PRE-FILTER



Safety Warning!

Service engineers should wear appropriate PPE, which may include, protective overalls, gloves, facemask and safety goggles when carrying out these procedures.

The oiled glass fibre in the media can cause irritation to eyes and skin. Flush eyes or Wash hands with copious amounts of cold water if affected by such contact.

1. Remove any hazardous materials and clean the inside of the enclosure.
2. Switch the cabinet ON to operate the fan(s) in order to create a safe (negative air pressure) environment within the acrylic enclosure.
3. Place a hazardous waste sack close to the cabinet in preparation.
4. Open the bi-folding front acrylic visor, fold the panels as necessary and hook the intake apertures over the two retaining brackets mounted on top of the fan housing.
5. Lift up one end of the pre-filter grille tray, slide it sideways slightly and then completely withdraw it from the underside of the filter housing.
6. Remove the saturated pre-filter element and place into the hazardous waste sack.

NOTE:

If it is intended to replace the main chemical filter during planned maintenance at this time, then prior to refitting the pre-filter and grille tray, spray the upstream side (contaminated side) of the Carbon filter with hair lacquer in-situ to reduce the risk of loosening contaminated carbon particles into the interior of the cabinet when the filter is handled for subsequent removal. This process can be done without opening the filter housing above.

Position a new pre-filter (either face up) in the grille tray and assemble the grille back into the unit. Repeat for the second pre-filter if fitted. Lift the front acrylic panel clear of the retaining brackets and close the front panel.

7. Locate a new pre-filter element into the grille tray.
8. Refit the grille tray with filter element back into the underside of the fan/filter housing.

Figure 3:

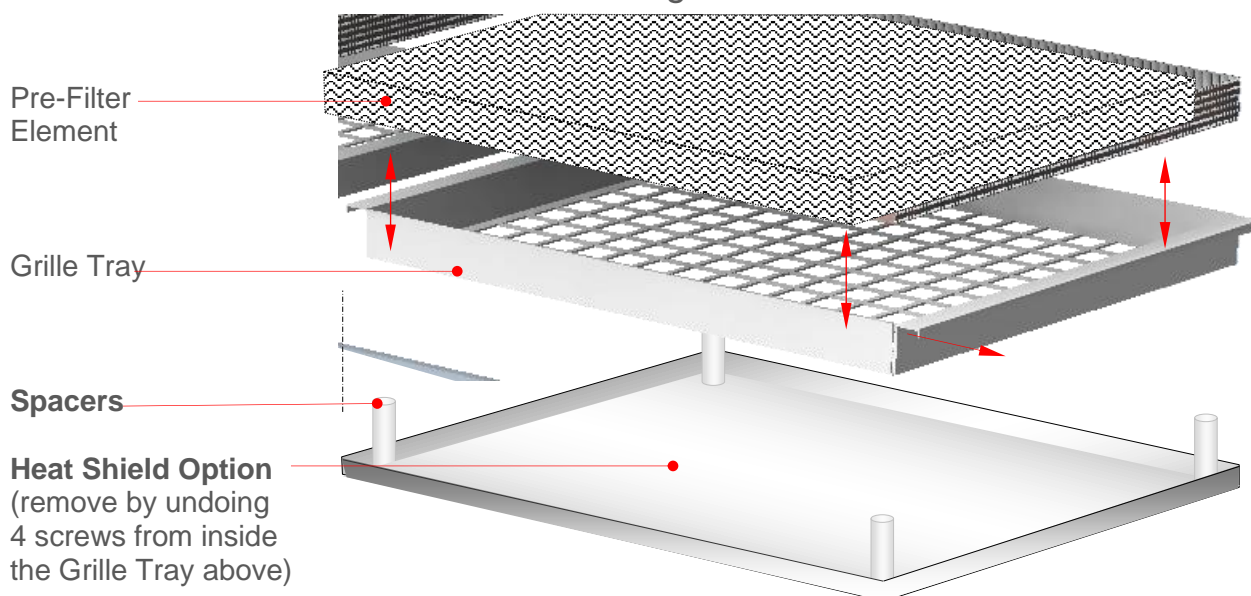

8.3 MAIN FILTER REMOVAL AND REPLACEMENT

8.3.1 PREPARATION



Safety Warning!

ENSURE THAT THE CABINET IS SWITCHED OFF AND ISOLATED FROM THE MAINS SUPPLY BEFORE OPENING THE FILTER HOUSING!

It is recommended that a trained service engineer should carry out the replacement of the main filter(s).

Wear appropriate PPE when handling contaminated filters.



- Ensure that a new Enviro chemical filter is only unpacked just prior to installing in position (stage:2).
- Place hazardous waste sacks close to the enclosure in preparation.
- Ensure that a HEPA filtered vacuum cleaner is available
- Place a clean plastic sheet close by to place the used filters on before bagging
- Remove all apparatus from the inside of the cabinet;

8.3.2 REPLACING CONTAMINATED FILTERS

1. To gain access to the main filters, first pull open the hinged front cover fully until the RH and LH internal sprung-loaded plungers locate fully into the holes in each side of the Fan/Filter housing. See Figure 5.
2. Elevate the hinged Fan/Filter housing clear of the filters below by rotating the nuts of both LH & RH threaded screw jacks. (Hand access to the screw jacks is provided by the LH and RH cavities). Beware of entrapment during this procedure. Rotate the RH and LH screw jacks in turn uniformly to lift the Fan/Filter housing clear. (Models 1506 and 2008 incorporate three and four screw jacks respectively)
3. Full access to the filter sets is now possible
4. Lift the HEPA filter (stage:4) off the back-up filter (stage:3) and place down onto a clean plastic sheet.
NOTES 2 & 4

NOTES:

- *The 'stiction' effect of the seals on all filters may make initial removal difficult, however, do not apply extreme movements to remove the filter from its position, otherwise carbon dust may be loosened and contaminate the local area.*
- *HEPA filters can be recognised by their anodised alloy casing*

5. Remove the back-up filter (stage:3) and place it on the clean plastic sheet

NOTES:

- *All Enviro carbon filters can be recognised by their distinctive black ABS casing*

6. Lift and remove the sampling chamber frame and place aside for re-use
7. Carefully remove the chemical filter (No:2) from the locating frame and place straight into a hazardous waste sack, seal and label.
8. Vacuum clean the frame area of the Fan/Filter housing and also wipe down with a damp cloth
9. Retrieve the original back-up chemical filter (stage:3) and carefully locate it into the position previously occupied by chemical filter (stage:2)
10. Refit the sampling chamber frame on top of new filter (stage:2) and carefully align with that filter
11. Position a new Enviro chemical filter on top the sampling chamber frame as back-up filter (stage:3).
12. Refit the original HEPA filter (No:4) on top of chemical filter (stage:3)
13. Lower the hinged fan/filter housing firmly onto the filters below by rotating the nuts of the screw jacks in reverse procedure to (b).
14. Unlatch each index plunger and lower the front cover down
15. Carry out airflow velocity checks and adjust fan speed as necessary.
16. Recalibrate the Nextion TFT alarm.

NOTE:

It is recommended that the HEPA filter should be replaced during this planned maintenance however, if it is known that it has not been heavily contaminated from previous use it may be judged to be reusable for a further period.

Figure 4

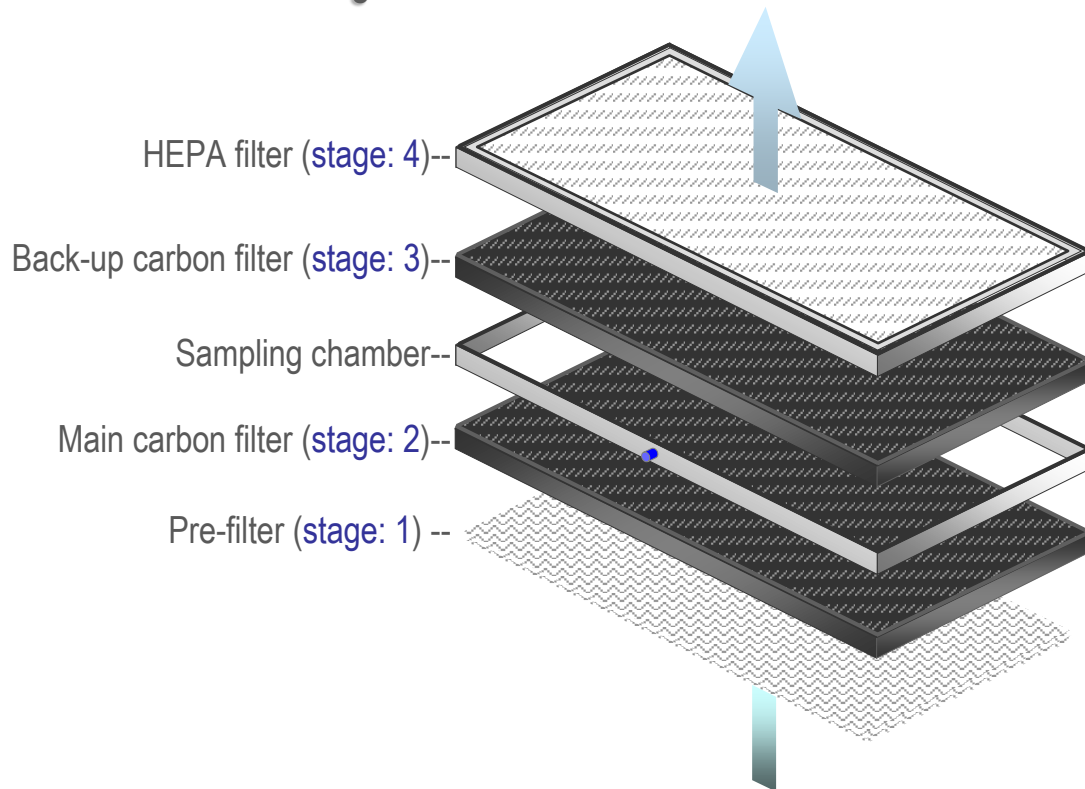
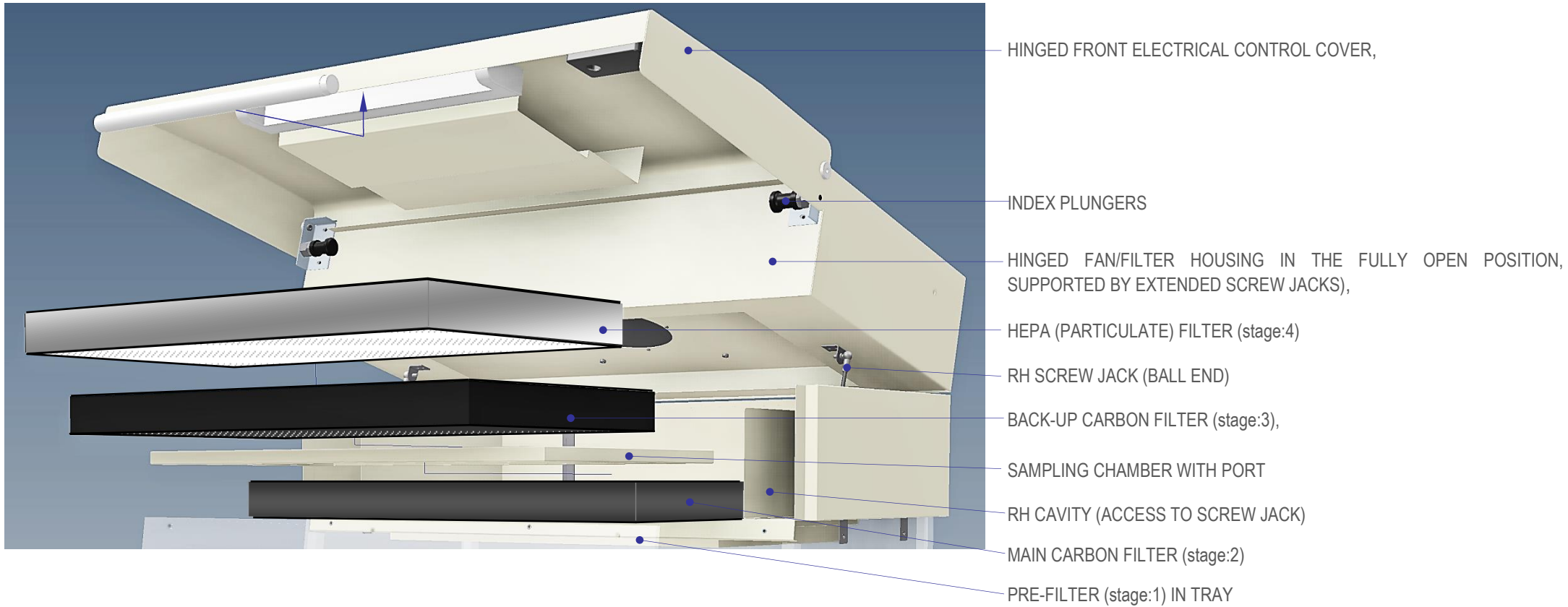

FIGURE 5: SCHEMATIC OF FILTER LAYOUT IN HOOD FOR PREVENTIVE MAINTENANCE



8.4 RESETTING AIRFLOW VELOCITY

Carry out airflow measurements and adjust fan speed as necessary. Recalibrate the 'Nextion TFT' airflow alarm. If further assistance is required to re-set the airflow velocity please refer to "*4.8 Normal Airflow Calibration Procedure*".

8.5 FILTER INTEGRITY TESTING

Please Refer to section “4.2 Filter Integrity Testing” for a guide on how to test the Carbon filters and if the unit has the optional HEPA filters fitted this section also has the method on to correctly test the HEPA Filters

8.6 GUIDELINES TO SELECTING THE CORRECT FILTER TYPE-CHANGE OF USE

It is important that the type of substance intended for use in this fume cabinet is identified in order to determine the correct choice of filters. This is particularly important if a change of use is intended. The risk assessment, classification, labelling and subsequent disposal of used filters is the responsibility of the end-user.

If a change of use of the cabinet is intended, then it is important to carry out a suitable risk assessment to identify the predominant vapour and /or particulate that is to be filtered.

NOTE:

The separate label fitted at the front of the fan housing identifies the actual filter type/filter combination fitted by Caron at first installation. It should be referred to in order to identify the correct filter replacement during planned maintenance, subject to any planned new usage and risk assessment.

8.7 TROUBLESHOOTING

The following fault symptoms and remedies are intended as a first level approach only and should be carried out by trained service personnel to isolate and rectify faults at this level.

Escalation and appropriate fault reporting should be made to Caron otherwise.

8.7.1 CONTROL SYSTEM FORMAT

The Chemcap PRO2 models use the Nextion TFT Controller unit which consists of:

- Control Pcb Bn4001.
- 12vdc Powers Supply
- 5vdc Power Supply
- Panel Mounted Sockets

Symptom	Remedial action
Fans Do Not Start:	<ul style="list-style-type: none"> • Check that electrical supply to the enclosure is available • Check that Fan rocker switch is on and illuminated • Contact Caron otherwise
Airflow Indication Low: Audible Alarm:	<ul style="list-style-type: none"> • Check that the fan is operational • Check that the bi-folding door is closed securely • Check pre-filter condition-replace in accordance with this manual • Check Main filter for saturation-replace in accordance with this manual • Check and re-adjust fan speed controller after filter change • Check calibration of the Nextion TFT alarm • Check fault status of Nextion alarm
Airflow Indication Too High:	<ul style="list-style-type: none"> • Fan speed controller requires re-calibration
Airflow Noise or Fan Vibration Excessive:	<ul style="list-style-type: none"> • Check for foreign objects in intake access apertures-remove • Fan bearing faulty [Contact Caron]

8.8 SPARE PARTS LIST

Part Number	Description
EF0071/01	EC FAN (230V)
EF0073/01	EC FAN (115V)
EC0097/01	PCB Control Board
EC0116/01	TFT Display
EP0060/02	12VDC PSU
EL0144/01	PLL LED LAMP
EP0060/03	24VDC LED PSU
EL0137/05 & EL0137/06	PR1004 LED
EL0137/06 Qty:2	PR1506 LED
EL0137/06 Qty:3	PR2008 LED

PRODUCT SPECIFICATIONS

MODEL	PR1004	PR1506	PR2008
PART No	PR1004	PR1506	PR2008
MAIN FILTER (2)	CARBON TYPE OS4	CARBON TYPE OS3 x2	CARBON TYPE OS4 x2
BK/UP FILTER (3)	CARBON TYPE OS4	CARBON TYPE OS3 x2	CARBON TYPE OS4 x2
HEPA FILTER (4)	HEPA HP4 (H-14)	HEPA HP4 (H-14) x2	HEPA HP4 (H-14) x2
OPENING TYPE	Trapezium		
FILTRATION (standard)	Chemcap Enviro™ Carbon Type OS (Main + backup), HEPA grade H-14		
FACE VELOCITY	0.5m/s ⁻¹		
FAN TYPE	EBM – PAPST R3G190-RC05-03 50Hz backward curve balanced centrifugal (230V)	EBM – PAPST R3G190-RC05-03 50Hz backward curve balanced centrifugal x2 (230V)	EBM – PAPST R3G190-RC05-03 50Hz backward curve balanced centrifugal x2 (230V)
	EBM – PAPST R3G190-RG15 -44 50/60Hz backward curve balanced centrifugal (115V)	EBM – PAPST R3G190-RG15 -44 50/60Hz backward curve balanced centrifugal x2 (115V)	EBM – PAPST R3G190-RG15 -44 50/60Hz backward curve balanced centrifugal x2 (115V)
FAN CONTROL	Nextion TFT airflow control system		
AIRFLOW ALARM	Nextion TFT airflow and alarm control system		
LIGHTING	Integrated LED lighting		
SOUND LEVEL	< 50dBA at 1 metre		
COMPLIANCE STANDARDS	BS7989:2001 Specification for recirculatory filtration fume cupboards		
	AFNOR NFX 15-211 Class 1 & 2 for filter retention capacity		
	AFNOR NFX 15-203 for containment		
	BS EN 61326:2013 Electrical equipment for measurement, control and laboratory use. EMC requirements.		

PRODUCT SPECIFICATIONS – POWER AND WEIGHT

MODEL	PR1004	PR1506	PR2008	PR1004	PR1506	PR2008
		-1			-4	
ELECTRICAL	110V – 120V 60 Hz,			230V +10% -6% 50 Hz		
POWER CONSUMPTION	108.64	193.52	199.28	109.64	195.52	201.28
LOAD AMPS	2.5A	4.0A		1.5A	2.5A	

MODEL	PR1004	PR1506	PR2008
NET WEIGHT	147Kg	215Kg	280Kg

FILTER SELECTION

Stock No.	Description	PR1004	PR1506	PR2008
ACF03/02	Acid Filter, size #3, Qty 2		•	
ACF04/01	Acid Filter, size #4, Qty 1	•		
ACF04/02	Acid Filter, size #4, Qty 2			•
AMF03/02	Ammonia Filter, size #3, Qty 2		•	
AMF04/01	Ammonia Filter, size #4, Qty 1	•		
AMF04/02	Ammonia Filter, size #4, Qty 2			•
FHF03/02	Formaldehyde Filter, size #3, Qty 2		•	
FHF04/01	Formaldehyde Filter, size #4, Qty 1	•		
FHF04/02	Formaldehyde Filter, size #4, Qty 2			•
HPF03/02	HEPA Filter, size #3, Qty 2		•	
HPF04/01	HEPA Filter, size #4, Qty 1	•		
HPF04/02	HEPA Filter, size #4, Qty 2			•
MPF03/02	Multi-Purpose Filter, size #3, Qty 2		•	
MPF04/01	Multi-Purpose Filter, size #4, Qty 1	•		
MPF04/02	Multi-Purpose Filter, size #4, Qty 2			•
OSF03/02	Organic Solvent Filter, size #3, Qty 2		•	
OSF04/01	Organic Solvent Filter, size #4, Qty 1	•		
OSF04/02	Organic Solvent Filter, size #4, Qty 2			•
PRF03/02	Prefilter, size #3, Qty 2		•	
PRF04/01	Prefilter, size #4, Qty 1	•		
PRF04/02	Prefilter, size #4, Qty 2			•
ULF03/02	ULPA Filter, size #3, Qty 2		•	
ULF04/01	ULPA Filter, size #4, Qty 1	•		
ULF04/02	ULPA Filter, size #4, Qty 2			•

DIMENSIONAL REFERENCES-PRO2 MODELS

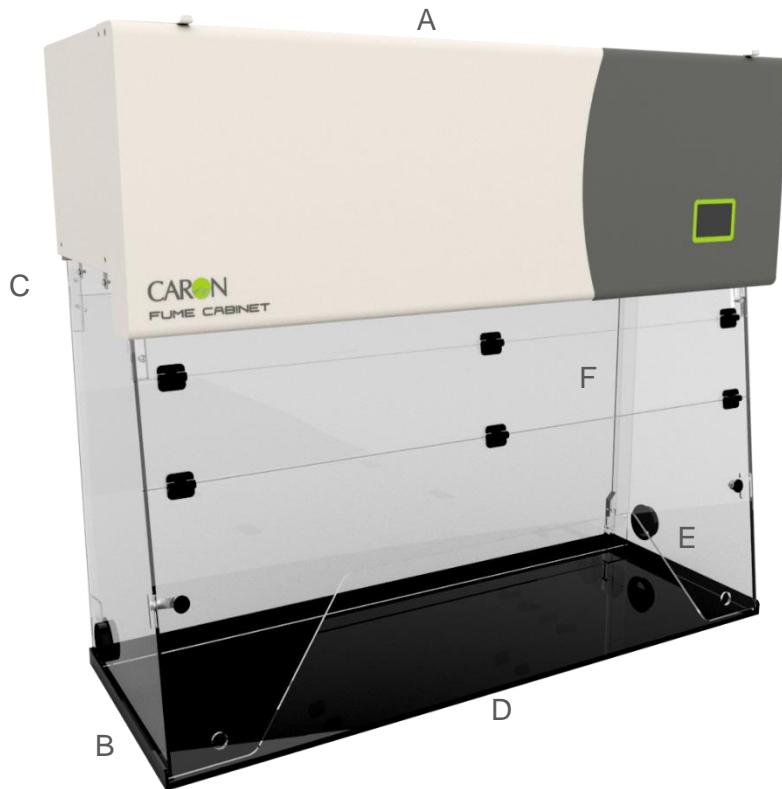

MODEL	'A' EXTERNAL WIDTH	'B' EXTERNAL DEPTH	'C' EXTERNAL HEIGHT	'D' INTERNAL WIDTH	'E' INTERNAL DEPTH	'F' INTERNAL HEIGHT
Pro 1004	1048mm	569mm	1248mm	968mm	506mm	807mm
Pro 1506	1548mm	569mm	1248mm	1468mm	506mm	807mm
Pro 2008	2048mm	569mm	1248mm	1968mm	506mm	807mm

EU DECLARATION OF CONFORMITY

QA Doc 92-0003 Rev 1



EU Declaration of Conformity

1. Product Model / Type:

Product Name:	Chemcap Clearview PRO2 ductless filtration fume cabinet
Model:	PR1004, PR1506, PR2008
Serial No.:	N/A
Operating Voltage and Frequency:	230V + 10% -6%, 50Hz, Single Phase 115V + 10% -6%, 60Hz, Single Phase (Harmonised Voltage)
Description/ Specifications:	<p>Photo</p> 

2. Manufacturer:

Bigneat Ltd t/a Caron Products, 4&5 Piper's Wood Industrial Park, Waterberry Drive, Waterlooville, Hampshire PO7 7XU, United Kingdom.

Tel +44-2392-266400.

Info@bigneat.com

www.bigneat.com

QA Doc 92-0003 Rev 1

3. This declaration is issued under the sole responsibility of the product manufacturer.
4. The object of the declaration described above is in conformity with the relevant Union harmonisation legislation and their amendments:

2006/42/EC	Machinery Directive
2014/30/EU	Electromagnetic Compatibility Directive
2011/65/EU	Restriction of Hazardous Substances in Electrical and Electronic Directive

5. We hereby declare that following harmonised standards have been applied to the product described above, to which this declaration of conformity refers to.

2006/42/EC:

EN ISO 12100:2010	Safety of machinery - General principles for design - Risk assessment and risk reduction
EN ISO 13849-1:2015	Safety of machinery — Safety-related parts of control systems — Part 1: General principles for design
EN 60204-1:2018	Safety of machinery - Electrical equipment of machines - Part 1: General requirements

2014/30/EU:

EN 61326-1:2013	Electrical Equipment for measurement, control and laboratory use – EMC requirements
EN 63000-3-2:2018	Electromagnetic compatibility (EMC) – Part 3-2: Limits – Limits for harmonic current emissions (equipment input current ≤ 16 A per phase)

2011/65/EU

EN 63000:2018	Technical documentation for the assessment of electrical and electronic products with respect to the restriction of hazardous substances
---------------	--

Other Applicable Standards:

BS 7989:2001	Specification for recirculatory filtration fume cupboards
EN 61010-1:2010+A1:2019	Safety requirements for electrical equipment for measurement, control and laboratory Use
EN 62311:2020	EMF Standard
AFNOR NFX 15-211-2009 CLASS 1	French Standard
ASHRAE 110-199 12-203 Containment	American Standard

QA Doc 92-0003 Rev 1

The following authorised representative is authorised by the manufacture to compile the technical file:

Name:	Casus Europe B.V.
Address (Authorised Representative):	Lange Viestraat 2b 3511 BK Utrecht The Netherlands.

Signed for & behalf of Bigneat Ltd t/a Caron:

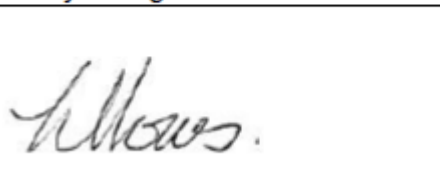
Place of issue:	UK
Date of Issue:	14 November 2023
Name:	Iain Howes
Function:	Quality Manager
Signature:	

UKCA DECLARATION OF CONFORMITY

QA Doc 93-0003 Rev 1



Declaration of Conformity

1. Product Model / Type:

Product Name:	Chemcap Clearview PRO2 ductless filtration fume cabinet
Model:	PR1004, PR1506, PR2008
Serial No:	N/A
Operating Voltage and Frequency:	230V + 10% -6%, 50Hz, Single Phase 115V + 10% -6%, 60Hz, Single Phase (Harmonised Voltage)
Description/ Specifications:	<p>Photo</p> 

2. Manufacturer (and Technical Documentation source):

Bigneat Ltd t/a Caron Products, 4&5 Piper's Wood Industrial Park, Waterberry Drive, Waterlooville, Hampshire PO7 7XU, UK.

Tel 02392-266400.

Info@bigneat.com

www.bigneat.com

QA Doc 93-0003 Rev 1

3. This declaration is issued under the sole responsibility of the product manufacturer.
4. The object of the declaration described above is in conformity with the relevant UK Statutory Instruments and their amendments:

SI 2008 No. 1597	The Supply of Machinery (Safety) Regulations 2008
SI 2016 No. 1091	Electromagnetic Compatibility Regulations 2016
SI 2012 No. 3032	The Restriction of the Use of Certain Hazardous Substances in Electrical and Electronic Equipment Regulations 2012

5. We hereby declare that the product described above, to which this declaration of conformity refers to, is in conformity with the essential requirements of the following designated standards:

SI 2008 No. 1597:

EN ISO 12100:2010	Safety of machinery - General principles for design - Risk assessment and risk reduction
EN ISO 13849-1:2015	Safety of machinery — Safety-related parts of control systems — Part 1: General principles for design
EN 60204-1:2018	Safety of machinery - Electrical equipment of machines - Part 1: General requirements

SI 2016 No. 1091

EN 61326-1:2013	Electrical Equipment for measurement, control and laboratory use – EMC requirements
EN 63000-3-2:2018	Electromagnetic compatibility (EMC) – Part 3-2: Limits – Limits for harmonic current emissions (equipment input current ≤ 16 A per phase)

SI 2012 No. 3032

EN 63000:2018	Technical documentation for the assessment of electrical and electronic products with respect to the restriction of hazardous substances
---------------	--

QA Doc 93-0003 Rev 1

Other Applicable Standards:

BS 7989:2001	Specification for recirculatory filtration fume cupboards
EN 61010-1:2010+A1:2019	Safety requirements for electrical equipment for measurement control, and laboratory use
EN 62311:2020	EMF Standard
AFNOR NFX 15-211-2009 CLASS 1	French Standard
ASHRAE 110-199 12-203 Containment	American Standard

Signed for & behalf of Bigneat Ltd t/a Caron:

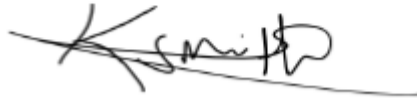
Place of issue:	4-5 pipers wood industrial park, Waterlooville, Hampshire, PO7 7XU
Date of Issue:	11/08/2023
Name:	Kelvin Robins-Smith
Function:	Engineering Manager (UK)
Signature:	

APPENDIX 1

General Assembly-schematic
Rear Baffle assembly/removal

APPENDIX 2 – ELECTRICAL SCHEMATIC

PR Product range

PR1004 -1: 115V, 1Φ, 60Hz, FLC 3.78A

PR1004-4: 230V, 1Φ, 50/60Hz, FLC 2.13A

PR1506/ PR2008-1: 115V, 1Φ, 60Hz, FLC 6.18A

PR1506/ PR2008-4: 230V, 1Φ, 50/60Hz, FLC 3.53A

PR Schematics
Document book

A	08/06/2023	zerpa.g	Initial Release
REV.	DATE	NAME	CHANGES
		4/5 Piper's Wood Industrial Park Waterberry Drive Waterlooville PO7 7XU	
		CONTRACT :	Checked By Zerpa.G Approved By Zerpa.G
		REVISION	A
		SCHEME	00

NOTE:
EARTH BOND ALL
PLATES & PANELS
AND ENSURE
CONTINUITY
BACK TO CONTROL PANEL STUD

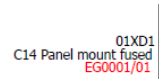

Note:
Refers note below for
fuse specification

1 FAN

PR1004-1 115VAC 60 Hz FLA = 3.78A Fuse= 5A Fuse Specification T/HBC 5A/20X5	PR1004-4 230VAC 50/60 Hz FLA = 2.13A Fuse= 3.15A Fuse Specification T/HBC 3.15A/20X5
---	--

2 FAN

PR1506/PR2008-1 115VAC 60 Hz FLA = 6.18A Fuse= 8A Fuse Specification T/HBC 8A/20X5	PR1506/PR2008-4 230VAC 50/60 Hz FLA = 3.53A Fuse= 5A Fuse Specification T/HBC 5A/20X5
--	---

FUSE SPECIFICATIONS:
HBC= HIGH BREAKING CAPACITY
F= FAST ASTING
T= ANTI-SURGE

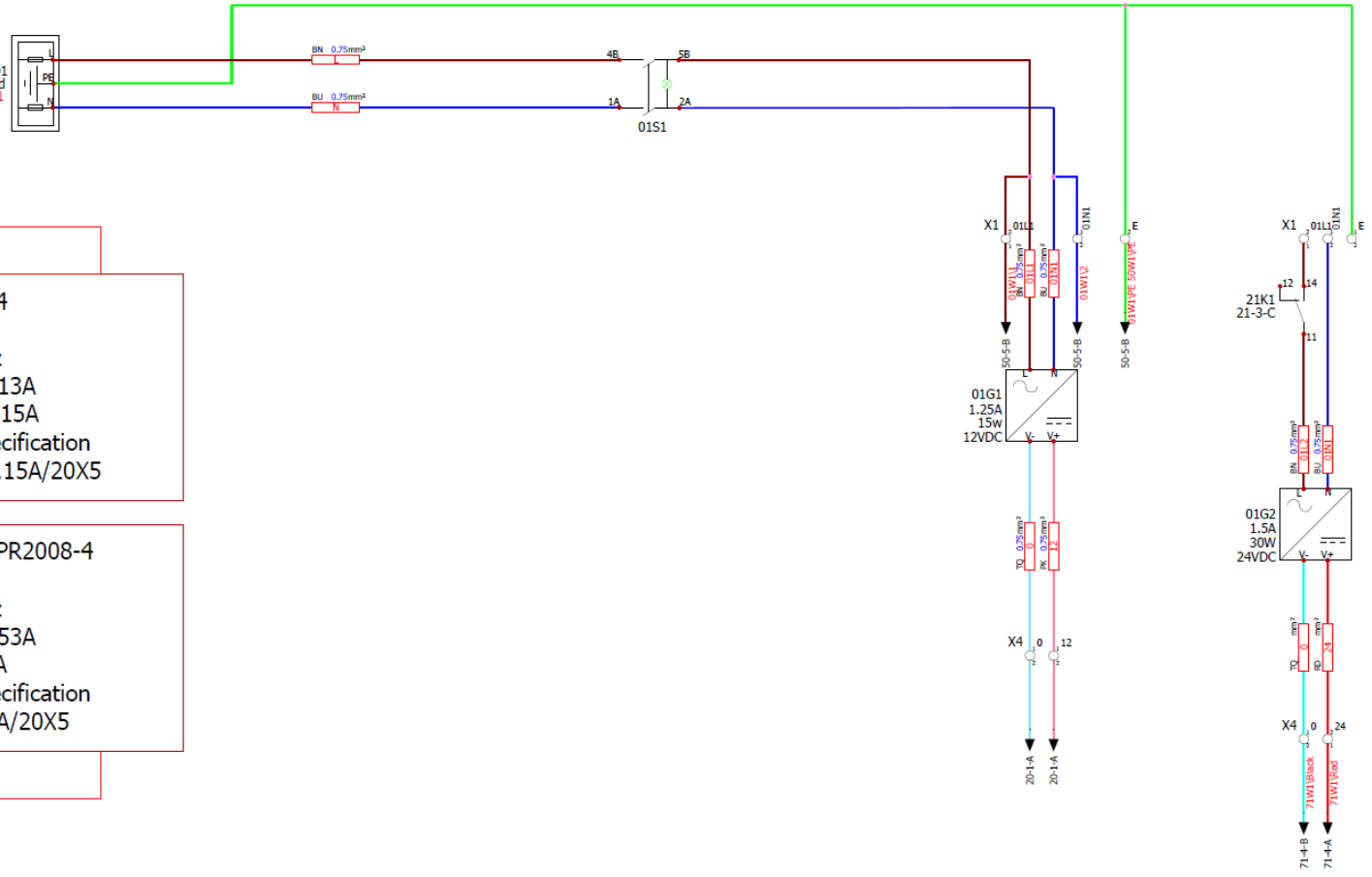

A					
	Initial Release	08/06/2023	08/06/2023	zerpa.g	zerpa.g
	REV NO:	DESCRIPTION:	VERIFIED DATE:	REV DATE:	ISSUED BY: REV BY:

PRODUCT:
Supply Voltage: 115Vac / 230Vac 50/60Hz
FLC: 6.18A (115Vac) / 3.53A (230Vac)
Plug Type: C14 Panel Mount

PCB PROGRAMME: Class1_260822_Rev1.X.production.hex
TFT PROGRAMME: CN_CLASS1_LAND_R01.tft

CARON[®] PROPRIETARY AND CONFIDENTIAL. THE INFORMATION CONTAIN IN THIS DRAWING IS THE SOLE PROPERTY OF BIDEAT LTD. ANY REPRODUCTION IN PART OR AS A WHOLE WITHOUT THE WRITTEN PERMISSION OF BIDEAT LTD IS PROHIBITED.

SHEET TITLE: **Power Distribution**

DRAWING NO: **PR Schematics**

DRAWN BY: zerpa.g
CHECKED BY:
DATE DRAWN: 08/06/2023
APPROVED BY:

SHEET: 01
NEXT: 20 of 304

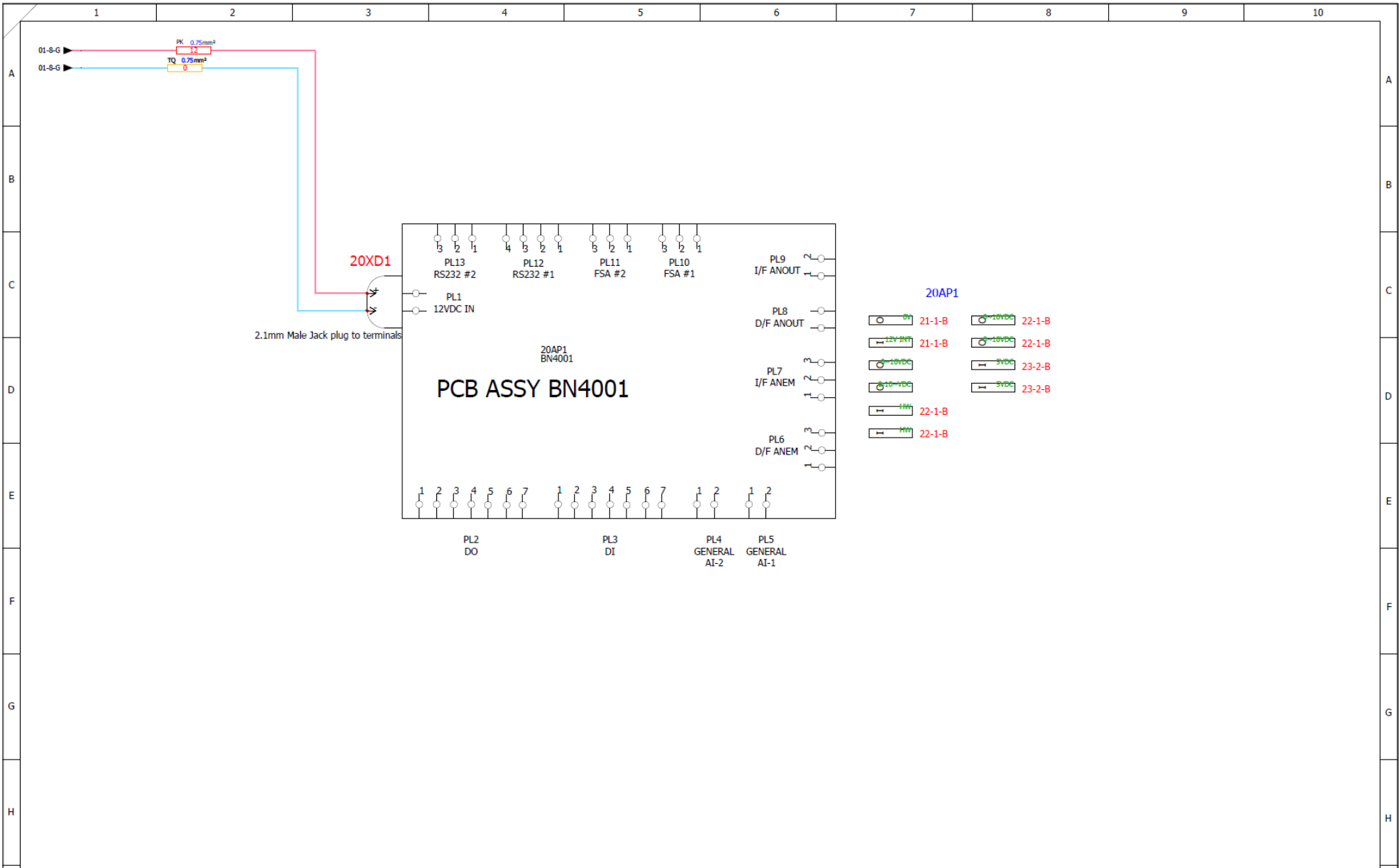

<table border="1"> <tr> <td>A</td> <td>Initial Release</td> <td>08/06/2023</td> <td>08/06/2023</td> <td>zerpa.g</td> <td>zerpa.g</td> </tr> <tr> <td>REV NO:</td> <td>DESCRIPTION:</td> <td>VERIFIED DATE:</td> <td>REV DATE:</td> <td>ISSUED BY:</td> <td>REV BY:</td> </tr> </table>						A	Initial Release	08/06/2023	08/06/2023	zerpa.g	zerpa.g	REV NO:	DESCRIPTION:	VERIFIED DATE:	REV DATE:	ISSUED BY:	REV BY:	PRODUCT: Supply Voltage: 115Vac / 230Vac 50/60Hz FLC: 6.18A (115Vac) / 3.53A (230Vac) Plug Type: C14 Panel Mount		PROPRIETARY AND CONFIDENTIAL. THE INFORMATION CONTAIN IN THIS DRAWING IS THE SOLE PROPERTY OF BIONEAT LTD. ANY REPRODUCTION IN PART OR AS A WHOLE WITHOUT THE WRITTEN PERMISSION OF BIONEAT LTD IS PROHIBITED.	
						A	Initial Release	08/06/2023	08/06/2023	zerpa.g	zerpa.g										
REV NO:	DESCRIPTION:	VERIFIED DATE:	REV DATE:	ISSUED BY:	REV BY:																
						SHEET TITLE: BN4001 Overview		DRAWING NO: PR Schematics		DRAWN BY: zerpa.g DATE DRAWN: 08/06/2023		CHECKED BY: APPROVED BY:		SHEET: 20 NDX: 21 of 304							

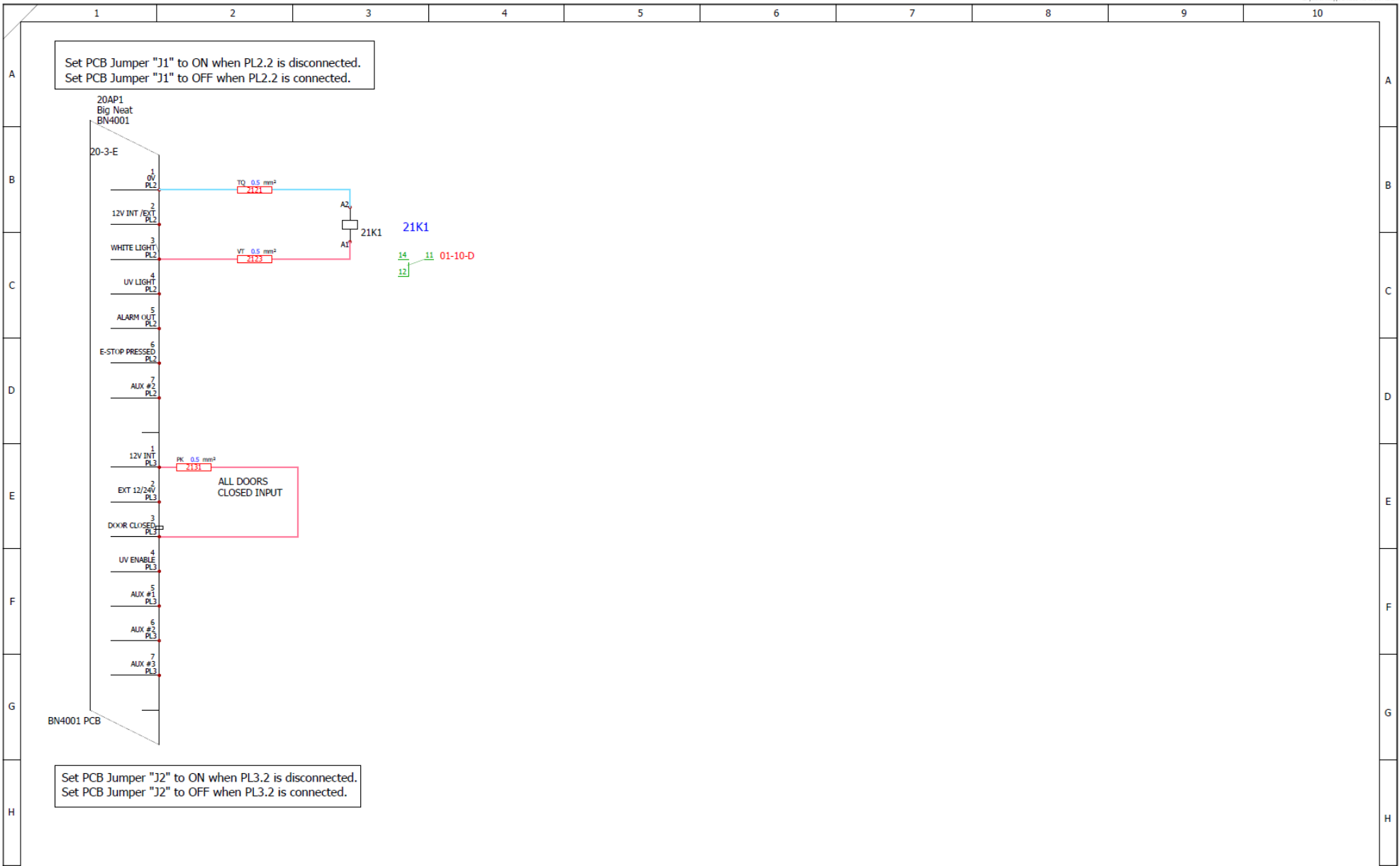

						PRODUCT: Supply Voltage: 115Vac / 230Vac 50/60Hz FLC: 6.18A (115Vac) / 3.53A (230Vac) Plug Type: C14 Panel Mount				<small>PROPRIETARY AND CONFIDENTIAL. THE INFORMATION CONTAIN IN THIS DRAWING IS THE SOLE PROPERTY OF BIGNEAT LTD. ANY REPRODUCTION IN PART OR AS A WHOLE WITHOUT THE WRITTEN PERMISSION OF BIGNEAT LTD IS PROHIBITED</small>	
						SHEET TITLE: Digital IO					
						DRAWING NO: PR Schematics		DRAWN BY: zerpa-g		CHECKED BY: [Blank]	
						PCB PROGRAMME: Class1_260822_Rev1.X.production.hex TFT PROGRAMME: CN_CLASS1_LAND_R01.tft		DATE DRAWN: 08/06/2023		APPROVED BY: [Blank]	
REV NO: A		DESCRIPTION: Initial Release		VERIFIED DATE: 08/06/2023		REV DATE: 08/06/2023		ISSUED BY: zerpa.g		REV BY: zerpa.g	
										SHEET: 21 NDT: 22 of 304	

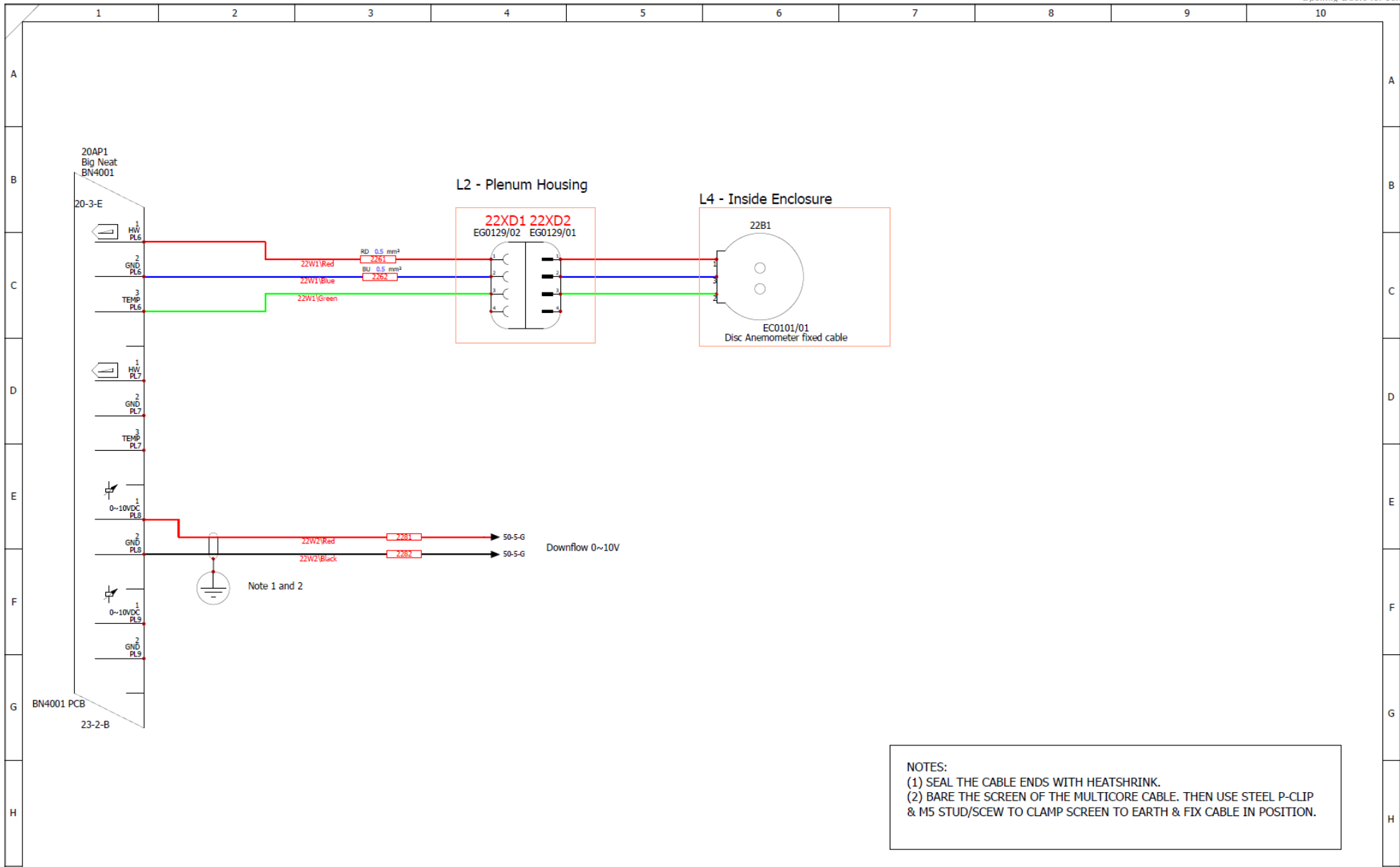

NOTES:
(1) SEAL THE CABLE ENDS WITH HEATSHRINK.
(2) BARE THE SCREEN OF THE MULTICORE CABLE. THEN USE STEEL P-CLIP & M5 STUD/SCEW TO CLAMP SCREEN TO EARTH & FIX CABLE IN POSITION.

I	A						PRODUCT: Supply Voltage: 115Vac / 230Vac 50/60Hz FLC: 6.18A (115Vac) / 3.53A (230Vac) Plug Type: C14 Panel Mount	PROPRIETARY AND CONFIDENTIAL. THE INFORMATION CONTAIN IN THIS DRAWING IS THE SOLE PROPERTY OF BIGNEAT LTD. ANY REPRODUCTION IN PART OR AS A WHOLE WITHOUT THE WRITTEN PERMISSION OF BIGNEAT LTD IS PROHIBITED. Analogue IO	SHEET TITLE:						
		REV NO:	DESCRIPTION:	VERIFIED DATE:	REV DATE:	ISSUED BY:	REV BY:			PCB PROGRAMME: Class1_260822_Rev1.X.production.hex TFT PROGRAMME: CN_CLASS1_LAND_R01.tft	DRAWING NO: PR Schematics	DRAWN BY: zerpa.g	CHECKED BY:	SHEET: 22	NEXT: 23 of 304
												DATE DRAWN: 08/06/2023	APPROVED BY:		

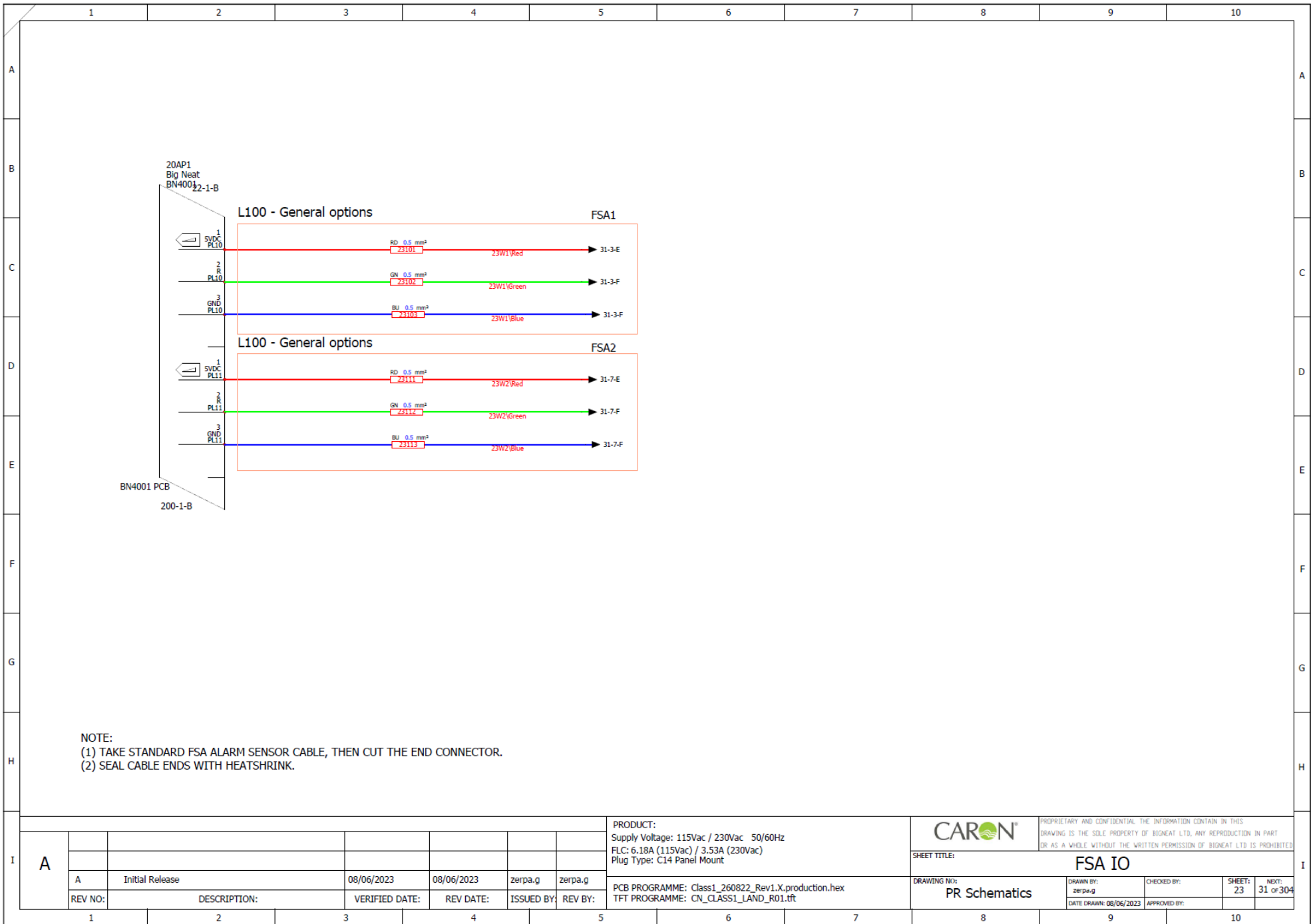

NOTE:
(1) TAKE STANDARD FSA ALARM SENSOR CABLE, THEN CUT THE END CONNECTOR.
(2) SEAL CABLE ENDS WITH HEATSHRINK.

PRODUCT: Supply Voltage: 115Vac / 230Vac 50/60Hz FLC: 6.18A (115Vac) / 3.53A (230Vac) Plug Type: C14 Panel Mount						PROPRIETARY AND CONFIDENTIAL. THE INFORMATION CONTAIN IN THIS DRAWING IS THE SOLE PROPERTY OF BIONEAT LTD. ANY REPRODUCTION IN PART OR AS A WHOLE WITHOUT THE WRITTEN PERMISSION OF BIONEAT LTD IS PROHIBITED.					
						SHEET TITLE: FSA IO					
DRAWING NO: PR Schematics		DRAWN BY: zerpa-g		CHECKED BY:		SHEET: 23		INDX: 31 of 304			
DATE DRAWN: 08/06/2023		APPROVED BY:									

L100 - General options

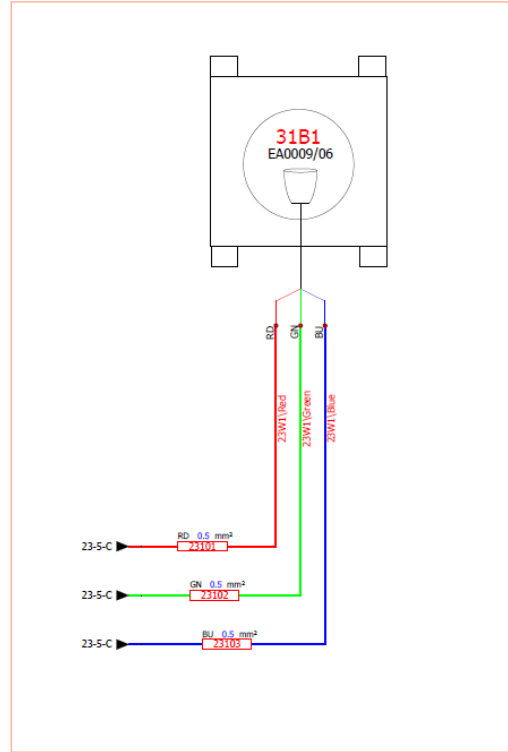

L100 - General options

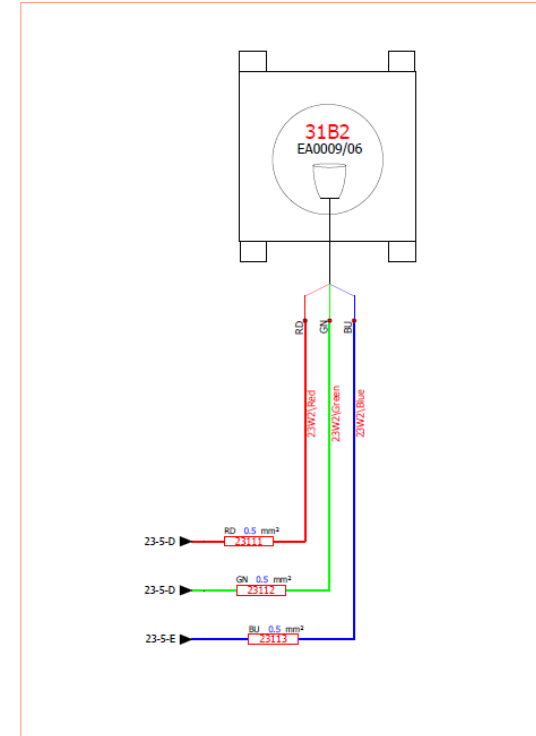

						PRODUCT: Supply Voltage: 115Vac / 230Vac 50/60Hz FLC: 6.18A (115Vac) / 3.53A (230Vac) Plug Type: C14 Panel Mount				PROPRIETARY AND CONFIDENTIAL. THE INFORMATION CONTAIN IN THIS DRAWING IS THE SOLE PROPERTY OF BIONEAT LTD. ANY REPRODUCTION IN PART OR AS A WHOLE WITHOUT THE WRITTEN PERMISSION OF BIONEAT LTD IS PROHIBITED.	
						SHEET TITLE: FSA Connection					
						DRAWING NO.: PR Schematics		DRAWN BY: zerpa.g		CHECKED BY: [Blank]	
						DATE DRAWN: 08/06/2023		APPROVED BY:		SHEET: 31 NEXT: 50 of 304	
REV NO: A		DESCRIPTION: Initial Release		VERIFIED DATE: 08/06/2023		REV DATE: 08/06/2023		ISSUED BY: zerpa.g		REV BY: zerpa.g	
PCB PROGRAMME: Class1_260822_Rev1.X.production.hex TFT PROGRAMME: CN_CLASS1_LAND_R01.tft											

FOR MODEL:
 PR1004-4 = USE 50M1
 PR1004-1 = USE 50M2
 PR1506/ PR2008-4 = USE 50M1 + PAGE 51
 PR1506/ PR2008-1 = USE 50M2 + PAGE 51

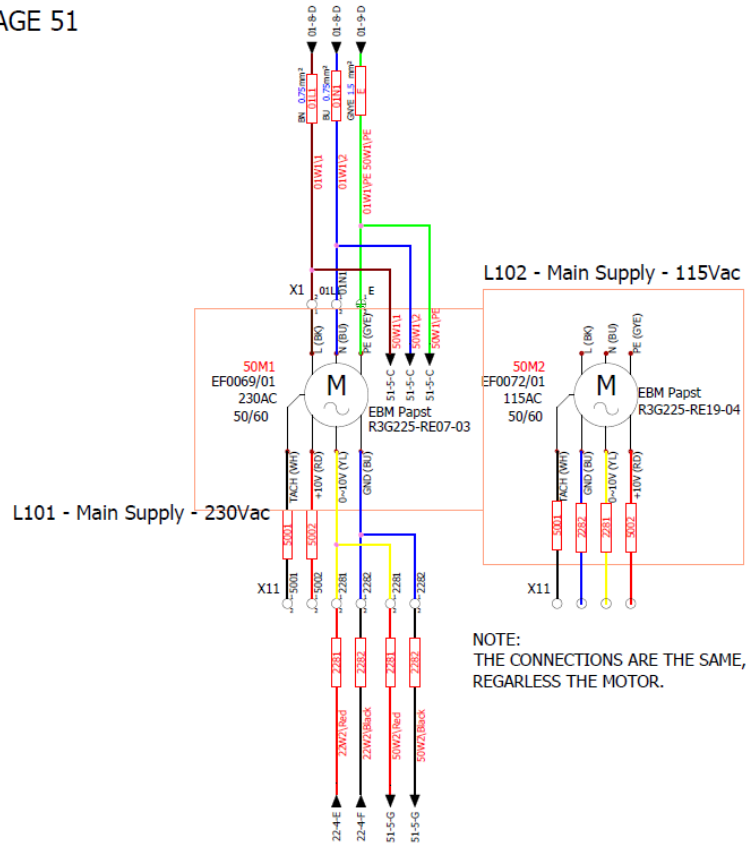

NOTE:
 THE CONNECTIONS ARE THE SAME,
 REGARDLESS THE MOTOR.

I	A					PRODUCT: Supply Voltage: 115Vac / 230Vac 50/60Hz FLC: 6.18A (115Vac) / 3.53A (230Vac) Plug Type: C14 Panel Mount	PROPRIETARY AND CONFIDENTIAL THE INFORMATION CONTAIN IN THIS DRAWING IS THE SOLE PROPERTY OF BIGEAT LTD, ANY REPRODUCTION IN PART OR AS A WHOLE WITHOUT THE WRITTEN PERMISSION OF BIGEAT LTD IS PROHIBITED SHEET TITLE: Downflow Fans Circuit 1	DRAWING NO: PR Schematics	DRAWN BY: zerpa.g DATE DRAWN: 06/06/2023	CHECKED BY: APPROVED BY:	SHEET: 50 NEXT: 51 of 304		
		REV NO:	DESCRIPTION:	VERIFIED DATE:	REV DATE:	ISSUED BY:						REV BY:	PCB PROGRAMME: Class1_260822_Rev1.X_production.hex TFT PROGRAMME: CN_CLASS1_LAND_R01.tft
			Initial Release	08/06/2023	08/06/2023	zerpa.g						zerpa.g	

FOR MODEL
PR1506/ PR2008-4 = USE 51M1 + PAGE 50
PR1506/ PR2008-1 = USE 51M2 + PAGE 50

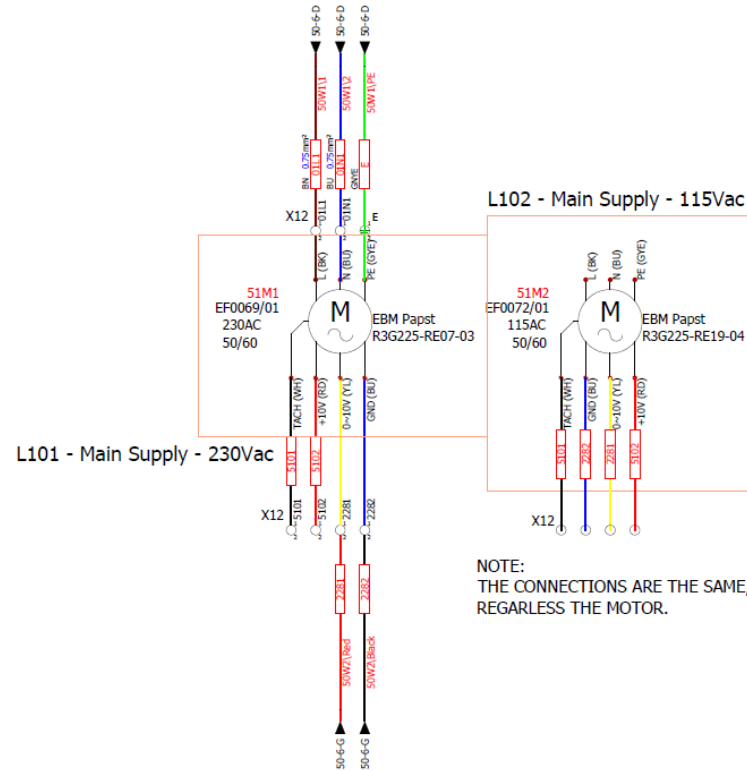

I	A					PRODUCT: Supply Voltage: 115Vac / 230Vac 50/60Hz FLC: 6.18A (115Vac) / 3.53A (230Vac) Plug Type: C14 Panel Mount	PROPRIETARY AND CONFIDENTIAL. THE INFORMATION CONTAIN IN THIS DRAWING IS THE SOLE PROPERTY OF BIGEAT LTD, ANY REPRODUCTION IN PART OR AS A WHOLE WITHOUT THE WRITTEN PERMISSION OF BIGEAT LTD IS PROHIBITED. SHEET TITLE: Downflow Fans Circuit 2	DRAWING NO: PR Schematics	DRAWN BY: zerpa.g	CHECKED BY:	SHEET: 51	NEXT: 71 of 304			
		REV NO:	DESCRIPTION:	VERIFIED DATE:	REV DATE:	ISSUED BY:							REV BY:	DATE DRAWN: 06/06/2023	APPROVED BY:

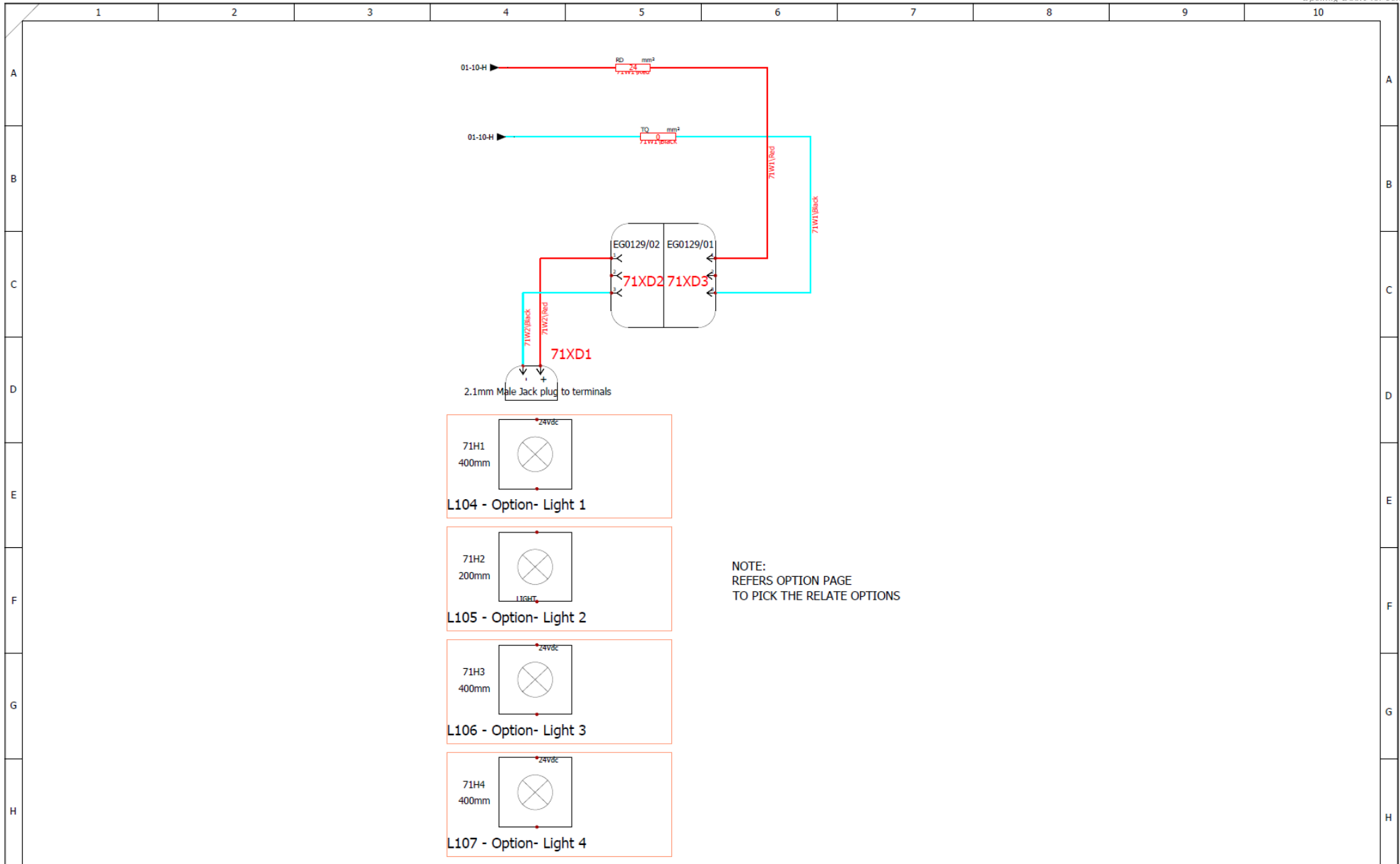

I	A							PRODUCT: Supply Voltage: 115Vac / 230Vac 50/60Hz FLC: 6.18A (115Vac) / 3.53A (230Vac) Plug Type: C14 Panel Mount	PROPRIETARY AND CONFIDENTIAL. THE INFORMATION CONTAIN IN THIS DRAWING IS THE SOLE PROPERTY OF BIONEAT LTD. ANY REPRODUCTION IN PART OR AS A WHOLE WITHOUT THE WRITTEN PERMISSION OF BIONEAT LTD IS PROHIBITED.		
		Initial Release	08/06/2023	08/06/2023	zerpa.g	zerpa.g	SHEET TITLE: White Lights connections (1)				
		REV NO:	DESCRIPTION:	VERIFIED DATE:	REV DATE:	ISSUED BY:	REV BY:	DRAWING NO: PR Schematics		DRAWN BY: zerpa-g	CHECKED BY:
							PCB PROGRAMME: Class1_260822_Rev1.X.production.hex TFT PROGRAMME: CN_CLASS1_LAND_R01.lft	DATE DRAWN: 08/06/2023	APPROVED BY:		

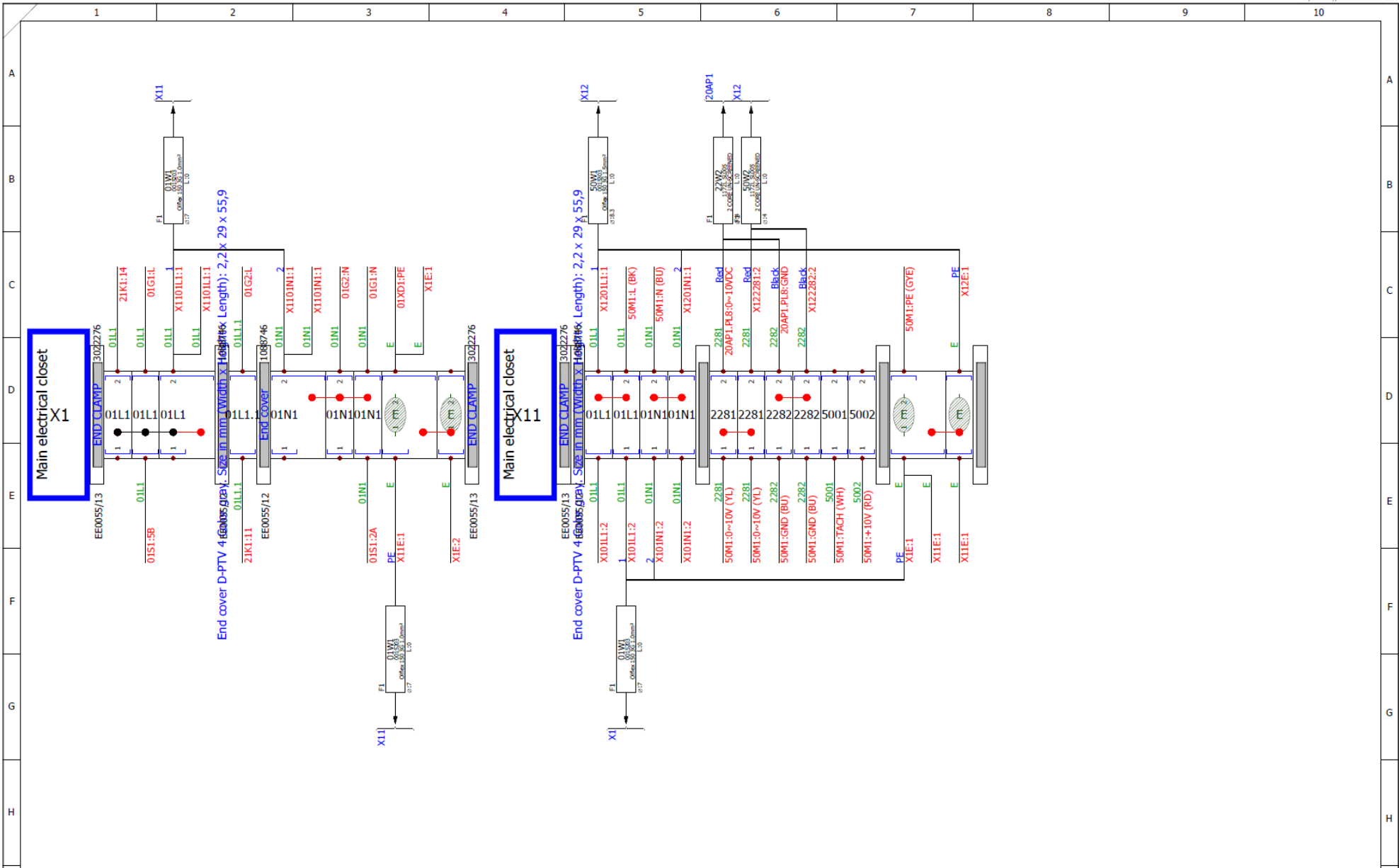

A	Initial Release	08/06/2023	08/06/2023	zerpa.g	zerpa.g
	REV NO:	DESCRIPTION:	VERIFIED DATE:	REV DATE:	ISSUED BY: REV BY:

PRODUCT:
Supply Voltage: 115Vac / 230Vac 50/60Hz
FLC: 6.18A (115Vac) / 3.53A (230Vac)
Plug Type: C14 Panel Mount

PCB PROGRAMME: Class1_260822_Rev1.X.production.hex
TFT PROGRAMME: CN_CLASS1_LAND_R01.ft

SHEET TITLE: X1-X11		DRAWING NO: PR Schematics		DRAWN BY: zerpa.g	CHECKED BY:	SHEET: 100	NOX: 102x304
DATE DRAWN: 08/06/2023		APPROVED BY:					

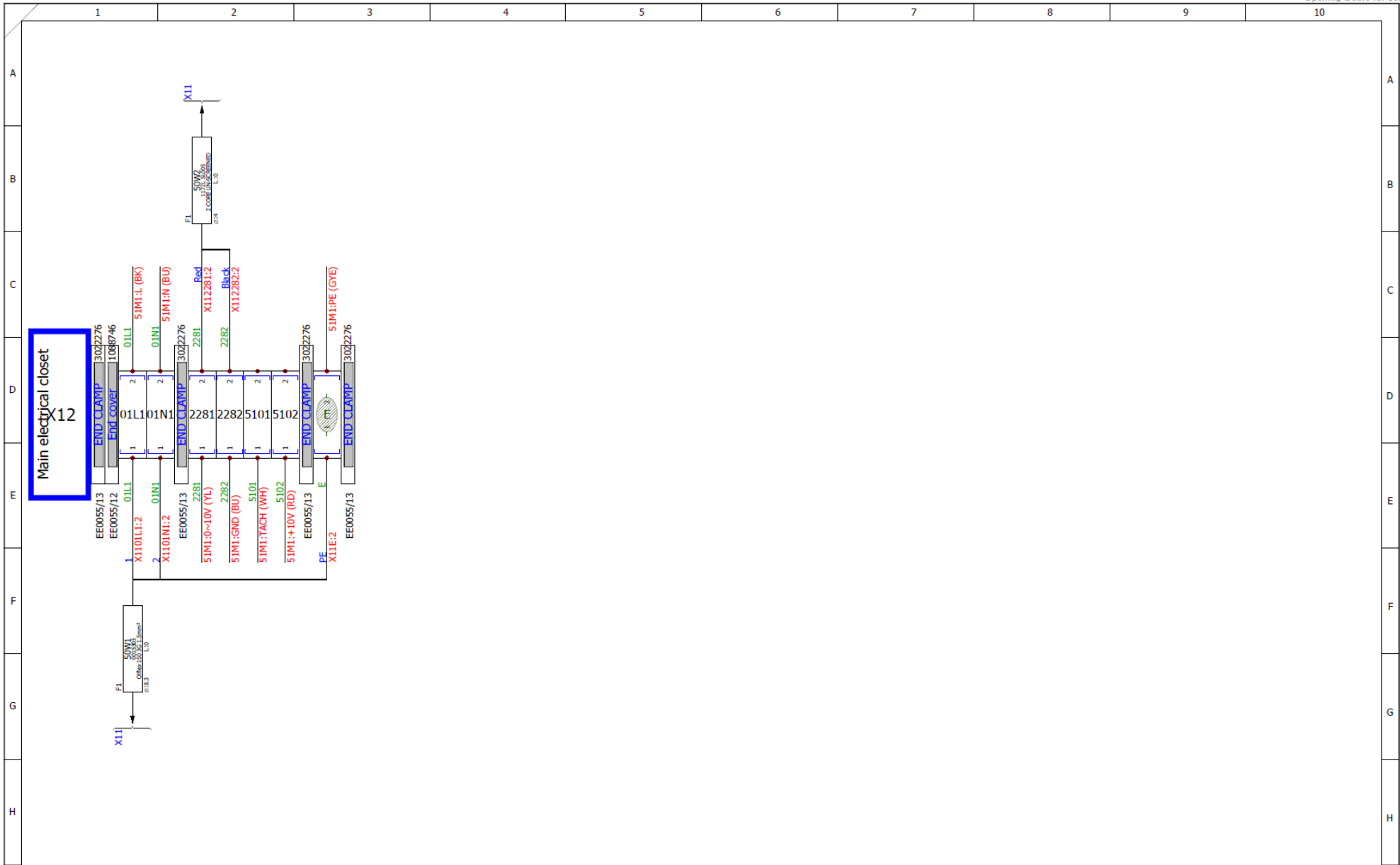

				PRODUCT: Supply Voltage: 115Vac/280Mac FLC: 6.18A (115Vac) / 3.53A (230Vac) Plug Type: C14 Panel Mount		PROPRIETARY AND CONFIDENTIAL. THE INFORMATION CONTAIN IN THIS DRAWING IS THE SOLE PROPERTY OF BIGEAT LTD. ANY REPRODUCTION IN PART OR AS A WHOLE WITHOUT THE WRITTEN PERMISSION OF BIGEAT LTD IS PROHIBITED.	
SHEET TITLE: X12-(1/1)				DRAWING NO: PR Schematics		DRAWN BY: zerpa.g CHECKED BY: REV: A SHEET: 102 of 304	
DATE DRAWN: 06/06/2023 APPROVED BY: zerpa.g				PCB PROGRAMME: Class1_260822_Rev1.X.production.hex TFT PROGRAMME: CN_CLASS1_LAND_R01.tft			
GRID REF:	REV NO:	DESCRIPTION:	REV DATE:	REV BY:			
1	A		08/06/2023	zerpa.g			

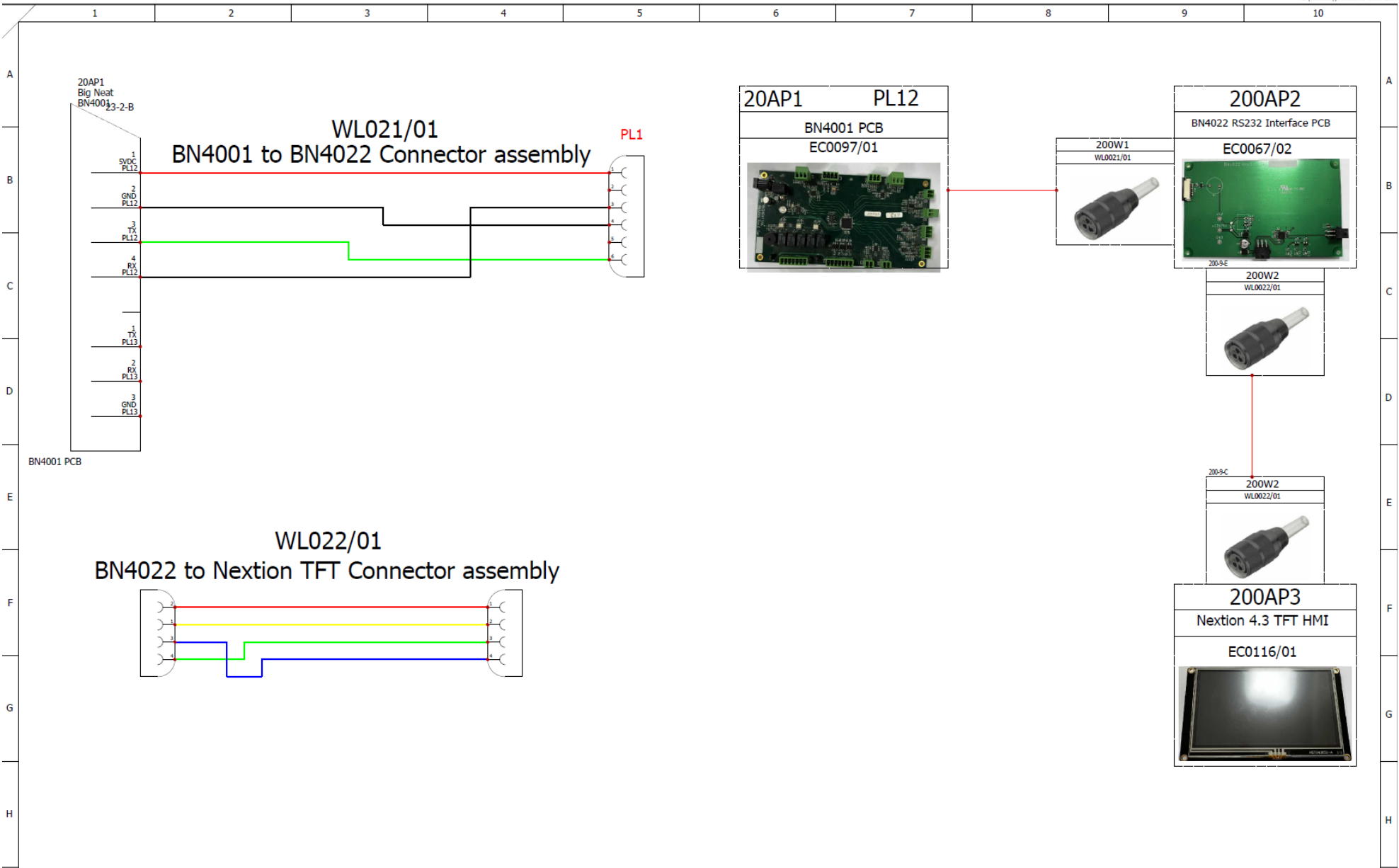

I	A							PRODUCT: Supply Voltage: 115Vac / 230Vac 50/60Hz FLC: 6.18A (115Vac) / 3.53A (230Vac) Plug Type: C14 Panel Mount	PROPRIETARY AND CONFIDENTIAL. THE INFORMATION CONTAIN IN THIS DRAWING IS THE SOLE PROPERTY OF BIGEAT LTD. ANY REPRODUCTION IN PART OR AS A WHOLE WITHOUT THE WRITTEN PERMISSION OF BIGEAT LTD IS PROHIBITED.
		Initial Release	08/06/2023	08/06/2023	zerpa.g	zerpa.g	SHEET TITLE: TFT Connections		
		REV NO:	DESCRIPTION:	VERIFIED DATE:	REV DATE:	ISSUED BY:	REV BY:	DRAWING NO: PR Schematics DRAWN BY: zerpa.g CHECKED BY: DATE DRAWN: 08/06/2023 APPROVED BY:	

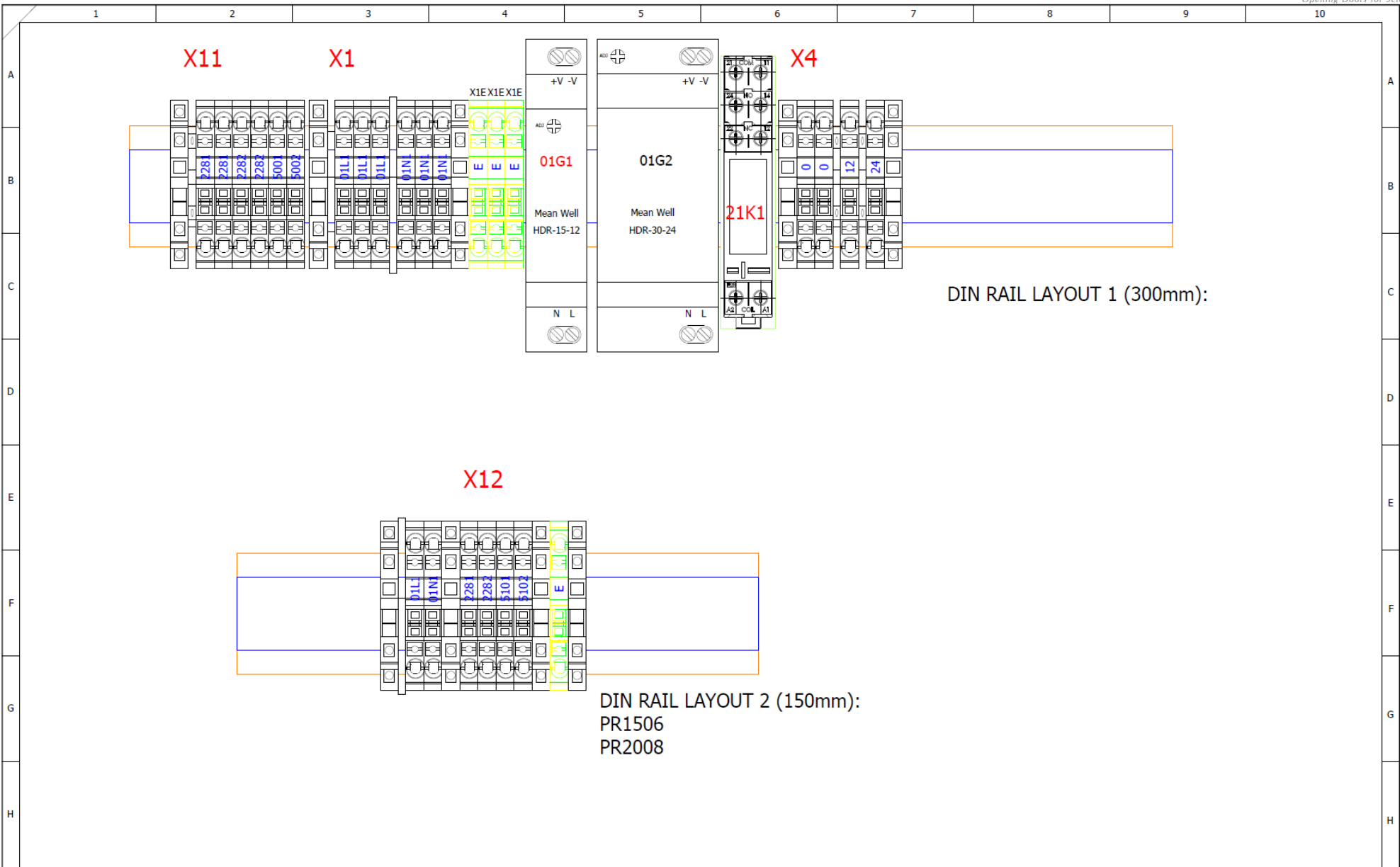

DIN RAIL LAYOUT 1 (300mm):

DIN RAIL LAYOUT 2 (150mm):
PR1506
PR2008

I	A					PRODUCT: Supply Voltage: 115Vac / 230Vac 50/60Hz FLC: 6.18A (115Vac) / 3.53A (230Vac) Plug Type: C14 Panel Mount		PROPRIETARY AND CONFIDENTIAL. THE INFORMATION CONTAIN IN THIS DRAWING IS THE SOLE PROPERTY OF BIGNET LTD. ANY REPRODUCTION IN PART OR AS A WHOLE WITHOUT THE WRITTEN PERMISSION OF BIGNET LTD IS PROHIBITED.	
						PCB PROGRAMME: Class1_260822_Rev1.X.production.hex TFT PROGRAMME: CN_CLASS1_LAND_R01.tft		SHEET TITLE: Din Rail Layout	
		REV NO:	DESCRIPTION:	VERIFIED DATE:	REV DATE:	ISSUED BY:	REV BY:	DRAWING NO: PR Schematics	DRAWN BY: zerpa.g CHECKED BY: DATE DRAWN: 08/06/2023 APPROVED BY:

NOTE:
THE ROUTE WIRING IS A SUGGESTION

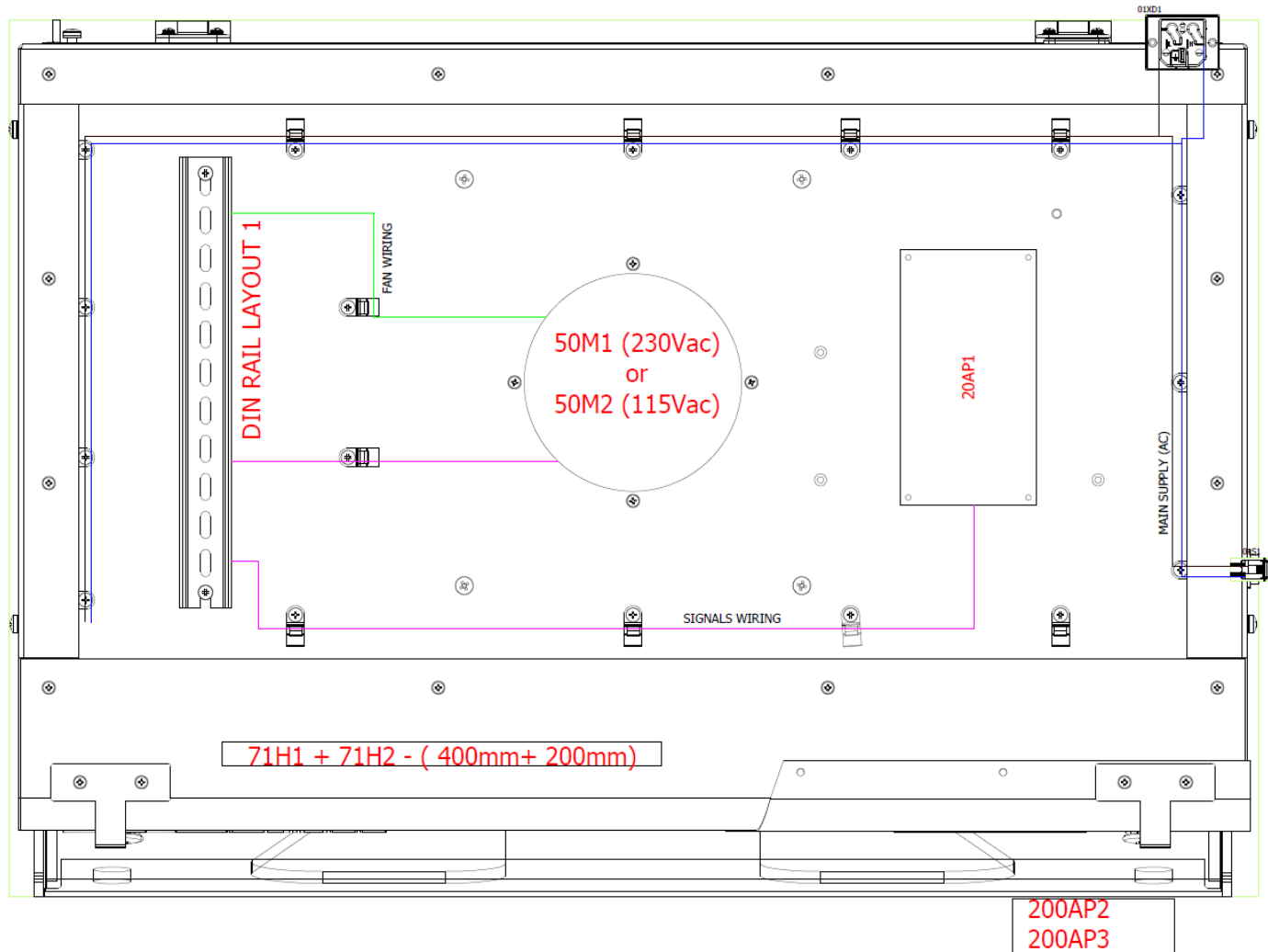

I	A							PRODUCT: Supply Voltage: 115Vac / 230Vac 50/60Hz FLC: 6.18A (115Vac) / 3.53A (230Vac) Plug Type: C14 Panel Mount	PROPRIETARY AND CONFIDENTIAL. THE INFORMATION CONTAIN IN THIS DRAWING IS THE SOLE PROPERTY OF BIONEAT LTD. ANY REPRODUCTION IN PART OR AS A WHOLE WITHOUT THE WRITTEN PERMISSION OF BIONEAT LTD IS PROHIBITED. SHEET TITLE: PR1004 Layout	I					
		REV NO:	DESCRIPTION:	VERIFIED DATE:	REV DATE:	ISSUED BY:	REV BY:	PCB PROGRAMME: Class1_260822_Rev1.X.production.hex TFT PROGRAMME: CN_CLASS1_LAND_R01.tft			DRAWING NO: PR Schematics	DRAWN BY: 26Pa-g	CHECKED BY:	SHEET: 202	NDY: 203 of 304
				08/06/2023	08/06/2023	zerpa.g	zerpa.g				DATE DRAWN: 08/06/2023	APPROVED BY:			

NOTE:
THE ROUTE WIRING IS A SUGGESTION

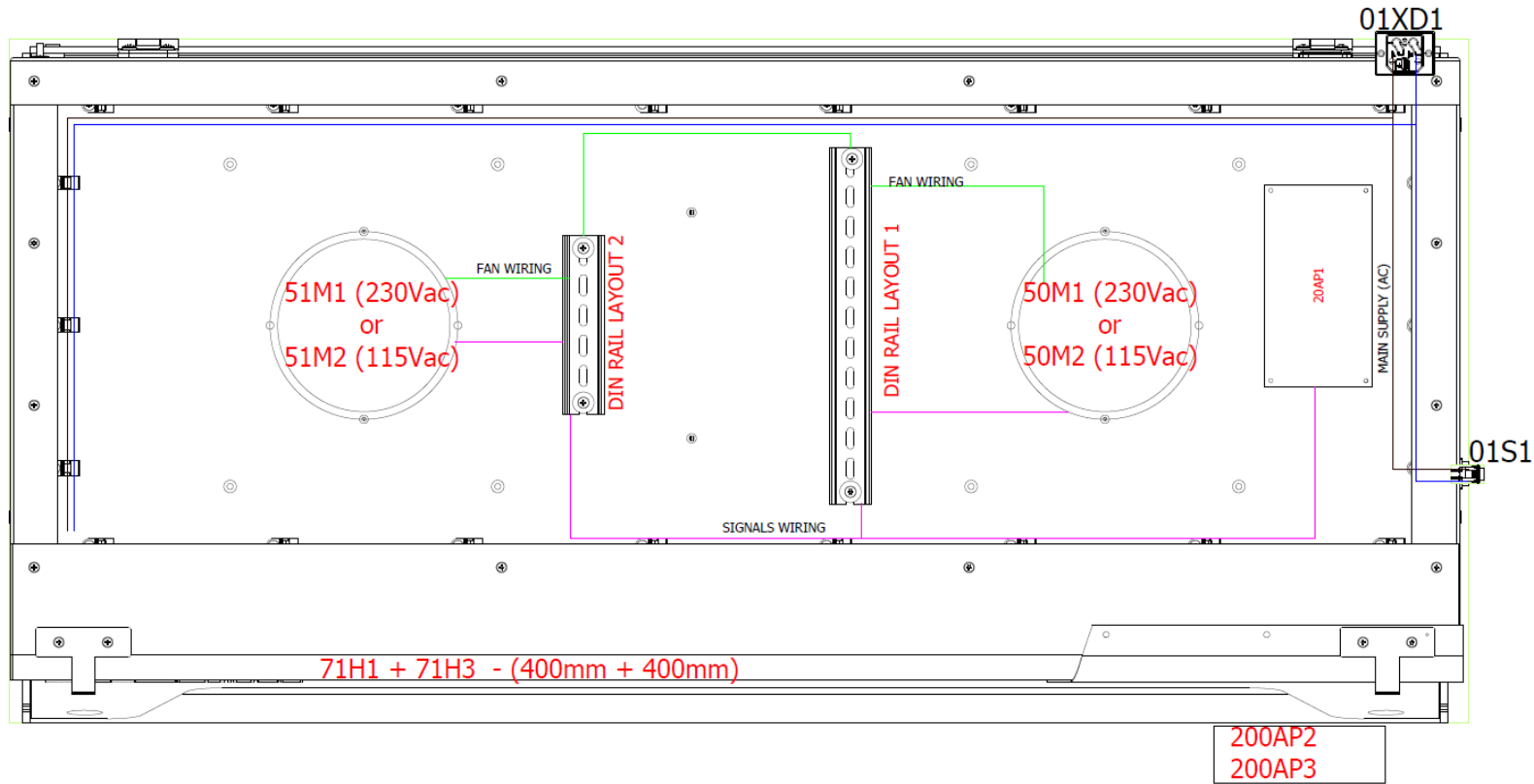

I	A						PRODUCT: Supply Voltage: 115Vac / 230Vac 50/60Hz FLC: 6.18A (115Vac) / 3.53A (230Vac) Plug Type: C14 Panel Mount	PROPRIETARY AND CONFIDENTIAL THE INFORMATION CONTAIN IN THIS DRAWING IS THE SOLE PROPERTY OF BIGEAT LTD, ANY REPRODUCTION IN PART OR AS A WHOLE WITHOUT THE WRITTEN PERMISSION OF BIGEAT LTD IS PROHIBITED	SHEET TITLE: PR1506 Layout				
		Initial Release	08/06/2023	08/06/2023	zerpa.g	zerpa.g	PCB PROGRAMME: Class1_260822_Rev1.X.production.hex TFT PROGRAMME: CN_CLASS1_LAND_R01.tft		DRAWING NO: PR Schematics	DRAWN BY: zerpa-g	CHECKED BY:	SHEET: 203	NEXT: 204fr304
		REV NO:	DESCRIPTION:	VERIFIED DATE:	REV DATE:	ISSUED BY:	REV BY:		DATE DRAWN: 08/06/2023	APPROVED BY:			

NOTE:
THE ROUTE WIRING IS A SUGGESTION

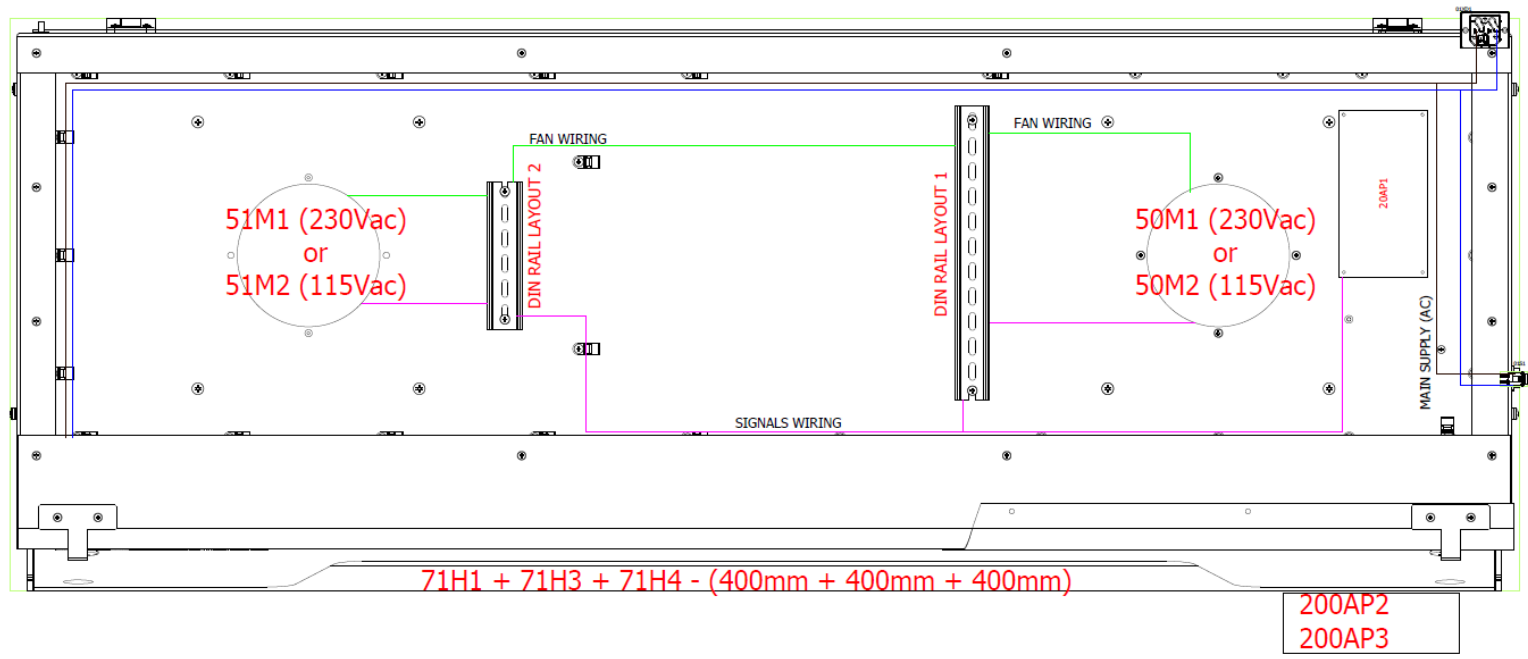

I	A							PRODUCT: Supply Voltage: 115Vac / 230Vac 50/60Hz FLC: 6.18A (115Vac) / 3.53A (230Vac) Plug Type: C14 Panel Mount	PROPRIETARY AND CONFIDENTIAL. THE INFORMATION CONTAIN IN THIS DRAWING IS THE SOLE PROPERTY OF BIGEAT LTD. ANY REPRODUCTION IN PART OR AS A WHOLE WITHOUT THE WRITTEN PERMISSION OF BIGEAT LTD IS PROHIBITED. SHEET TITLE: PR2008 Layout	DRAWING NO: PR Schematics	DRAWN BY: zerpa.g	CHECKED BY:	SHEET: 204	NEXT: 300x304
		REV NO:	DESCRIPTION:	VERIFIED DATE:	REV DATE:	ISSUED BY:	REV BY:	PCB PROGRAMME: Class1_260822_Rev1.X.production.hex TFT PROGRAMME: CN_CLASS1_LAND_R01.tft			DATE DRAWN: 08/06/2023	APPROVED BY:		
		1	2	3	4	5	6	7			8	9	10	